



GÜVEN

ELEKTRİK ELEKTRONİK LTD. ŞTİ.

GWEST®

WWOER®



MAYIS 2020
FİYAT LİSTESİ

İÇİNDEKİLER

Kablo Bağları ve Aksesuarları

Standart Beyaz Kablo Bağları	02
Standart Siyah Kablo Bağları	03
Standart Renkli Kablo Bağları	04
Ultraviöle Kablo Bağları	05
Paslanmaz Çelik Kablo Bağları	06
Paslanmaz Çelik Etiket	06
PVC Kaplı Paslanmaz Çelik Kablo Bağları	07
Etiketli Kablo Bağları	08
Açılabilir Kablo Bağları	08
Distanslı Kablo Bağları	08
Yapışkanlı Kroşeler	09
Kapama Parçası	09
Kablo Kelepçesi	09
Kartuş Yükseltici	10
Beton Kroşe	10
Vidalı Kroşe	10
Kablo Bağı Etiket Taşıyıcı	11
Pano Etiket Taşıyıcı	11
Kablo İşaretleme Sistemleri	11
Helezon Spiraller	12

Kablo Yüksükleri ve Papuçları

İzoleli Kablo Yüksükleri Fransız Normu	14
İzoleli Kablo Yüksükleri Alman Normu	15
Çift Girişli Kablo Yüksükleri Fransız Normu	16
Çift Girişli Kablo Yüksükleri Alman Normu	17
İzolesiz Kablo Yüksükleri	18
Yuvarlak Tip İzoleli Kablo Uçları	20
Çatal Tip İzoleli Kablo Uçları	21
Ek Mufları İzoleli Kablo Uçları	22
Erkek Terminalleri İzoleli Kablo Uçları	22
Dişi Terminaller İzoleli Kablo Uçları	22
Dişi Faston Tip İzoleli Kablo Uçları	23
Tam İzoleli Dişi Faston Tip Kablo Uçları	23
Tam İzoleli Polyamid Dişi Faston Tip Kablo Uçları	23
İğne Tip İzoleli Kablo Uçları	24
Erkek / Dişi Geri Dönümlü Terminaller	24
Dişi Terminaller İzoleli Kablo Uçları	24
Erkek Faston Tip Terminaller	25
Vidalı Buat Klemensleri	25
Hızlı Kablo Ekleme Parçası	25
İzolesiz Kablo Ucu ve Konnektörleri	26

Bağlantı Elemanları

SKP-E Ekonomik Tip Kablo Papucu	28
SKP-S Standart Tip Kablo Papucu	29
Ek Mufları	30
U Klemens	31
Montaj Rayları	31
Monofaze Müşterek W Otomat Baraları	33
Trifaze Müşterek W Otomat Baraları	33
2 Kutuplu Dağıtıcı Üniteler	34
4 Kutuplu Dağıtıcı Üniteler	35
Tek Kutuplu Dağıtıcı Üniteler	36
Tek Kutuplu Dağıtıcı Üniteler	37

Kompakt Çok Amaçlı Klemensler

Geçmeli Buat Klemens	39
Çok Amaçlı Klemens	39

Makaron Grubu ve Bant Çeşitleri

Isı ile Daralan Siyah Makaronlar	41
Isı ile Daralan Renkli Makaronlar	42
Isı ile Daralan Renkli Makaronlar	43
Isı ile Daralan Sarı / Yeşil Makaronlar	44
İçi Yapışkanlı Daralan Makaronlar	45
Kablo Toplama Çorabı	47
H Class Cam Elyaf Silikon İzoleli Makaronlar	48
PVC İzoleli Cam Elyaf Makaronlar	49
Eriyen Bantlar.....	50
İzole Bantlar	50
Sıcak Hava Tabancası	50

Mekanik ve Hidrolik El Aletleri

Yüksük Sıkma Penseleri	52
İzolesiz Kablo Ucu ve Konnektör Sıkma Penseleri	53
İzoleli Kablo Ucu ve Konnektör Sıkma Penseleri	54
Konnektör Sıkma Penseleri	54
Multi Fonksiyonel Yüksük ve Kablo Ucu Sıkma Pensesi	54
Kablo Sıyırıcılar	55
Kablo Bağı Sıkma Penseleri	55
Kablo Papucu Sıkma Penseleri	56
Hidrolik Sıkma ve Kesme Penseleri	56
Kablo Kesme Makasları	57

İÇİNDEKİLER

Buton Serisi ve Aksesuarları

Yaylı Butonlar	59
İşaretli Yaylı Butonlar	59
Işıklı Yaylı Butonlar	59
Kalıcı Mandal Butonlar	60
Kayıcı Mandal Butonlar	60
Kalıcı - Kayıcı Mandal Butonlar	60
Anahtarlı Kalıcı Butonlar	60
Işıklı Mandal Butonlar	61
40mm Kalıcı Mantar Butonlar	62
40mm Kalıcı Anahtarlı Mantar Butonlar	62
40mm Kayıcı Mantar Butonlar	62
40mm Kalıcı Mantar Butonlar	62
İkiz Butonlar	63
Buton Aksesuarları	64
Boş Kumanda Kutuları	65
Kutulu Acil Stop Buton	65
Ø 22mm Voltmetre	66
Ø 22mm Ampermetre	66
Ø 22mm Led'li Sinyaller	67
Ø 16mm Led'li Sinyaller	67
BA9S Led Ampuller	68
Metal Led'li Sinyaller	69
Ø 22mm Led'li Buzzer	70
Ø 22mm Ses'li Buzzer	70
Motorlu Sirenler	70
Elektronik Sirenler	70
Ø 22mm Potansiyometre	71
Pano İçi Termostatlar	71
Aks Serisi Kapı Siviçleri	71
Vinç Kumanda Butonları	73

Switch Grubu

GLS Serisi Limit Switch	74
GLS Serisi Limit Switch	75
GLS Serisi Limit Switch	76
GLS Serisi Limit Switch	77
AZ Serisi Mikro Switch	78
AZ Serisi Mikro Switch	79
AZ Serisi Mikro Switch	80
GMS Serisi Mikro Switch	81

Ayak Pedalları

Metal Döküm Pedal	83
Alüminyum Döküm Pedal.....	83



Bu fiyat listesindeki tipografik baskı hatalarından firmamız sorumlu değildir.

Firmamız fiyat listesinde yayınlanmış olduğu teknik özellikleri değiştirme, döviz ve hammadde artışlarından dolayı meydana gelebilecek fiyat artışlarını hiçbir uyarıda bulunmaksızın fiyat listesine yansıtma hakkına sahiptir.



GÜVEN
ELEKTRİK ELEKTRONİK LTD. ŞTİ.

Whatsapp Sipariş Destek Hattı
+90 850 304 88 36
www.guvenelektrik.com.tr

Başarılar Karşılıklı GÜVEN'e Bağlıdır.

Şirketimiz 2004 yılında kurulmuş olup kurulduğu tarihten bugüne ithalatlara her sene üzerine ekleyerek devam etmektedir. Genç ve dinamik yapısı ile müşterilerinin ihtiyaçlarına hızlı, etkili ve pratik çözümler sunmaktadır. Bugün'e kadar çalışmış olduğu müşterilerine koşulsuz müşteri memnuniyeti yaşatan Güven Elektrik hizmetlerine kalite standartlarını yükselterek devam etmektedir.

Firmamıza ait olan tescilli GWEST, WOER, FLK markaları ile siz değerli müşterilerimize 16 yıllık tecrübe ve müşteri memnuniyetini ilke edinerek hizmet vermekten mutluluk duyuyoruz.

WOER[®]
www.woer.com.tr

GWEST[®]
www.gwest.com.tr

FLK[®]
www.flk.com.tr

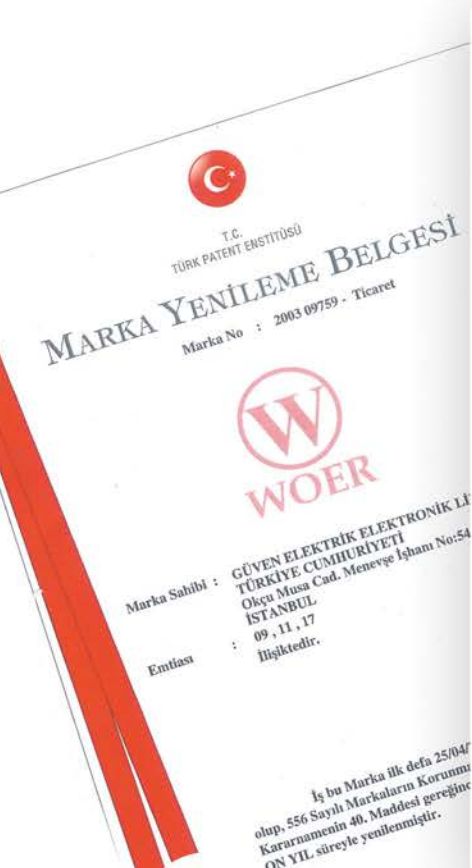



GÜVEN
ELEKTRİK ELEKTRONİK LTD. ŞTİ.

KABLO BAĞLARI ve AKSESUARLAR



www.guvenelektrik.com.tr

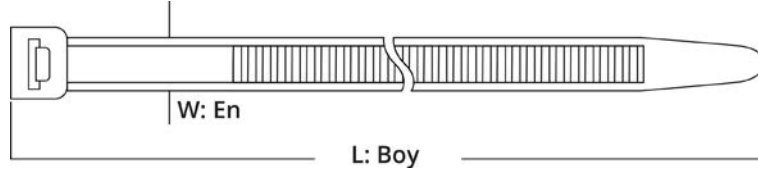

Malzeme :

Saf Naylon 6.6 Standart UL

Çalışma Sıcaklığı :

- 40 °C --- +85 °C

STANDART BEYAZ KABLO BAĞLARI

Sipariş Kodu	Ürün Kodu	Boyutlar		Renk	Maksimum Sıkma Çapı (mm)	Açılma Mukavemeti (kg)	Ambalaj Adet		Birim Fiyat TL / Adet
		Uzunluk (mm)	En (mm)				Paket	Koli	
1001	GT 100 M	100	2.5	Beyaz	20	8	1.000	70.000	0.040
1002	GT 150 M	150		Beyaz	36		1.000	55.000	0.062
1003	GT 200 M	200		Beyaz	52		1.000	32.000	0.080
1004	GT 150 I	150	3.6	Beyaz	36	18	100	30.000	0.095
1005	GT 200 I	200		Beyaz	52		100	20.000	0.130
1006	GT 250 I	250		Beyaz	68		100	20.000	0.160
1007	GT 300 I	300		Beyaz	84		100	17.000	0.200
1008	GT 370 I	370		Beyaz	106		100	12.000	0.240
1009	GT 200 ST	200	4.8	Beyaz	50	22	100	16.000	0.170
1010	GT 250 ST	250		Beyaz	65		100	12.000	0.230
1011	GT 300 ST	300		Beyaz	81		100	11.000	0.265
1012	GT 370 ST	370		Beyaz	104		100	9.000	0.340
1050	GT 400 ST	400		Beyaz	113		100	6.500	0.380
1013	GT 430 ST	430		Beyaz	123		100	7.500	0.430
1014	GT 530 ST	530		Beyaz	160		100	5.000	0.575
1015	GT 300 HD	300	7.6	Beyaz	76	55	100	5.000	0.520
1016	GT 370 HD	370		Beyaz	102		100	4.000	0.620
1017	GT 430 HD	430		Beyaz	110		100	2.500	0.770
1018	GT 530 HD	530		Beyaz	140		100	2.000	0.950
1019	GT 610 HD	610		Beyaz	185		100	2.000	1.050
1020	GT 750 HD	750		Beyaz	226		100	2.000	1.300
1022	GT 710 HD	710	9	Beyaz	190	80	100	2.000	1.550
1023	GT 780 HD	780		Beyaz	228		100	2.000	1.750
1024	GT 920 HD	920		Beyaz	280		100	1.000	1.950
1025	GT 1020 HD	1020		Beyaz	295		100	1.000	2.200
1026	GT 1220 HD	1220		Beyaz	375		100	1.000	2.800

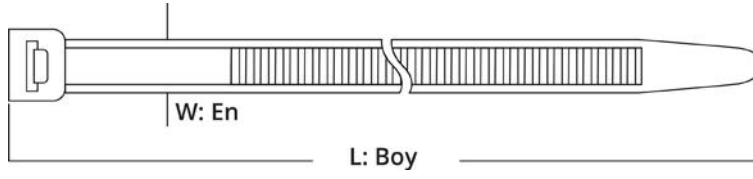
Malzeme :

Saf Naylon 6.6 Standart UL

Çalışma Sıcaklığı :

- 40 ° C --- +85 ° C

STANDART SİYAH KABLO BAĞLARI

Sipariş Kodu	Ürün Kodu	Boyutlar		Renk	Maksimum Sıkma Çapı (mm)	Açılma Mukavemeti (kg)	Ambalaj Adet		Birim Fiyat TL / Adet
		Uzunluk (mm)	En (mm)				Paket	Koli	
1027	GT 100 MB	100	2.5	Siyah	20	8	1.000	70.000	0.040
1028	GT 150 MB	150		Siyah	36		1.000	55.000	0.062
1029	GT 200 MB	200		Siyah	52		1.000	32.000	0.080
1030	GT 150 IB	150	3.6	Siyah	36	18	100	30.000	0.095
1031	GT 200 IB	200		Siyah	52		100	20.000	0.130
1032	GT 250 IB	250		Siyah	68		100	20.000	0.160
1033	GT 300 IB	300		Siyah	84		100	17.000	0.200
1034	GT 370 IB	370		Siyah	106		100	12.000	0.240
1035	GT 200 STB	200	4.8	Siyah	50	22	100	16.000	0.170
1036	GT 250 STB	250		Siyah	65		100	12.000	0.230
1037	GT 300 STB	300		Siyah	81		100	11.000	0.265
1038	GT 370 STB	370		Siyah	104		100	9.000	0.340
1039	GT 430 STB	430		Siyah	123		100	7.500	0.430
1040	GT 530 STB	530		Siyah	160		100	5.000	0.575
1041	GT 300 HDB	300	7.6	Siyah	76	55	100	5.000	0.520
1042	GT 370 HDB	370		Siyah	102		100	4.000	0.620
1043	GT 430 HDB	430		Siyah	110		100	2.500	0.770
1044	GT 530 HDB	530		Siyah	140		100	2.000	0.950
1045	GT 610 HDB	610		Siyah	185		100	2.000	1.050
1048	GT 710 HDB	710	9	Siyah	190	80	100	2.000	1.550
1049	GT 780 HDB	780		Siyah	228		100	2.000	1.750

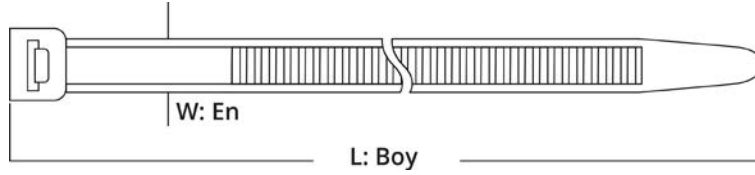
Malzeme :

Saf Naylon 6.6 Standart UL

Çalışma Sıcaklığı :

- 40 °C --- +85 °C

STANDART RENKLİ KABLO BAĞLARI

Sipariş Kodu	Ürün Kodu	Boyutlar		Renk	Maksimum Sıkma Çapı (mm)	Açılma Mukavemeti (kg)	Ambalaj Adet		Birim Fiyat TL / Adet
		Uzunluk (mm)	En (mm)				Paket	Koli	
1101	GT 100 MK	100	2.5	Kırmızı	20	8	1.000	70.000	0.045
1102	GT 150 IK	150	3.6	Kırmızı	36	18	100	30.000	0.110
1103	GT 200 IK	200		Kırmızı	52		100	20.000	0.150
1104	GT 250 IK	250		Kırmızı	68		100	20.000	0.185
1105	GT 300 IK	300		Kırmızı	84		100	17.000	0.230
1106	GT 200 STK	200	4.8	Kırmızı	50	22	100	16.000	0.200
1107	GT 250 STK	250		Kırmızı	65		100	12.000	0.270
1108	GT 300 STK	300		Kırmızı	81		100	11.000	0.320
1109	GT 370 STK	370		Kırmızı	101		100	9.000	0.400
1110	GT 100 MM	100	2.5	Mavi	20	8	1.000	70.000	0.045
1111	GT 150 IM	150	3.6	Mavi	36	18	100	30.000	0.110
1112	GT 200 IM	200		Mavi	52		100	20.000	0.150
1113	GT 250 IM	250		Mavi	68		100	20.000	0.185
1114	GT 300 IM	300		Mavi	84		100	17.000	0.230
1115	GT 200 STM	200	4.8	Mavi	50	22	100	16.000	0.200
1116	GT 250 STM	250		Mavi	65		100	12.000	0.270
1117	GT 300 STM	300		Mavi	81		100	11.000	0.320
1118	GT 370 STM	370		Mavi	101		100	9.000	0.400
1119	GT 100 MS	100	2.5	Sarı	20	8	1.000	70.000	0.045
1120	GT 150 IS	150	3.6	Sarı	36	18	100	30.000	0.110
1121	GT 200 IS	200		Sarı	52		100	20.000	0.150
1122	GT 250 IS	250		Sarı	68		100	20.000	0.185
1123	GT 300 IS	300		Sarı	84		100	17.000	0.230
1124	GT 200 STS	200	4.8	Sarı	50	22	100	16.000	0.200
1125	GT 250 STS	250		Sarı	65		100	12.000	0.270
1126	GT 300 STS	300		Sarı	81		100	11.000	0.320
1127	GT 370 STS	370		Sarı	104		100	9.000	0.400
1128	GT 100 MY	100	2.5	Yeşil	20	8	1.000	70.000	0.045
1129	GT 150 IY	150	3.6	Yeşil	36	18	100	30.000	0.110
1130	GT 200 IY	200		Yeşil	52		100	20.000	0.150
1131	GT 250 IY	250		Yeşil	68		100	20.000	0.185
1132	GT 300 IY	300		Yeşil	84		100	17.000	0.230
1133	GT 200 STY	200	4.8	Yeşil	50	22	100	16.000	0.200
1134	GT 250 STY	250		Yeşil	65		100	12.000	0.270
1135	GT 300 STY	300		Yeşil	81		100	11.000	0.320
1136	GT 370 STY	370		Yeşil	101		100	9.000	0.400

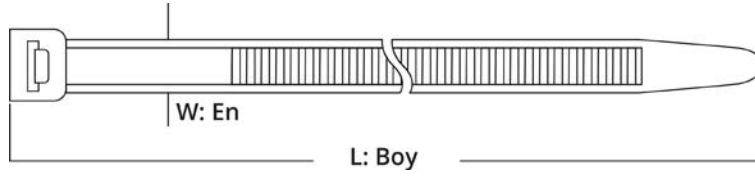
Malzeme :

Saf Naylon 6.6 Standart UL

Çalışma Sıcaklığı :

- 40 °C --- +85 °C

ULTRAVIOLE KABLO BAĞLARI

Sipariş Kodu	Ürün Kodu	Boyutlar		Renk	Maksimum Sıkma Çapı (mm)	Açılma Mukavemeti (kg)	Ambalaj Adet		Birim Fiyat TL / Adet
		Uzunluk (mm)	En (mm)				Paket	Koli	
1201	GT 100 M UV	100	2.5	Siyah	20	8	1.000	70.000	0.045
1202	GT 150 M UV	150		Siyah	36		1.000	55.000	0.072
1203	GT 200 M UV	200		Siyah	52		1.000	32.000	0.100
1204	GT 150 I UV	150	3.6	Siyah	36	18	100	30.000	0.110
1205	GT 200 I UV	200		Siyah	52		100	20.000	0.150
1206	GT 250 I UV	250		Siyah	68		100	20.000	0.210
1207	GT 300 I UV	300		Siyah	84		100	17.000	0.240
1208	GT 200 ST UV	200	4.8	Siyah	50	22	100	16.000	0.210
1209	GT 250 ST UV	250		Siyah	65		100	12.000	0.270
1210	GT 300 ST UV	300		Siyah	81		100	11.000	0.350
1211	GT 370 ST UV	370		Siyah	104		100	9.000	0.430
1212	GT 430 ST UV	430		Siyah	123		100	7.500	0.480
1213	GT 300 HD UV	300	7.6	Siyah	76	55	100	5.000	0.590
1214	GT 370 HD UV	370		Siyah	102		100	4.000	0.720
1215	GT 430 HD UV	430		Siyah	110		100	2.500	0.900
1216	GT 530 HD UV	530		Siyah	140		100	2.000	1.150
1217	GT 780 HD UV	780	9	Siyah	228	80	100	2.000	2.000



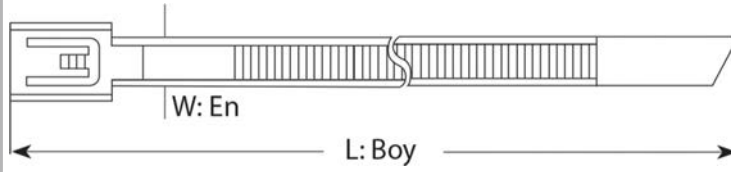

Malzeme : 304 Paslanmaz Çelik
Su emilimi : Yok
Alev yürmeme : UL94V-2

PASLANMAZ ÇELİK KABLO BAĞLARI

Sipariş Kodu	Ürün Kodu	Boyutlar		Renk	Maksimum Sıkma Çapı (mm)	Açılma Mukavemeti (kg)	Ambalaj Adet		Birim Fiyat TL / Adet
		Uzunluk (mm)	En (mm)				Paket	Koli	
1301	MTL 150 ST	150	4.6	Metal	44	55	100	8.000	0.950
1302	MTL 200 ST	200		Metal	51		100	6.000	1.100
1303	MTL 260 ST	260		Metal	69		100	5.000	1.200
1304	MTL 300 ST	300		Metal	76		100	5.000	1.300
1305	MTL 370 ST	370		Metal	102		100	4.000	1.450
1306	MTL 520 ST	520		Metal	152		100	3.000	1.750
1307	MTL 680 ST	680		Metal	203		100	2.000	2.300
1308	MTL 840 ST	840		Metal	254		100	1.000	2.750
1309	MTL 200 HD	200	7.9	Metal	50	120	100	5.000	1.650
1310	MTL 300 HD	300		Metal	75		100	4.000	1.850
1311	MTL 370 HD	370		Metal	102		100	3.000	2.100
1312	MTL 520 HD	520		Metal	152		100	2.000	2.700
1313	MTL 680 HD	680		Metal	203		100	2.000	3.200
1314	MTL 840 HD	840		Metal	224		100	1.000	3.800

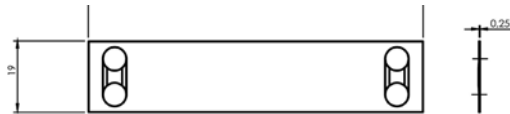

Malzeme : 304 Paslanmaz Çelik
Su emilimi : Yok
Alev yürmeme : UL94V-2

PASLANMAZ ÇELİK ETİKET

Sipariş Kodu	Ürün Kodu	Açıklama	Renk	Boy ve Genişlik (mm)	Ambalaj Adet	Birim Fiyat TL / Adet
1351	MTL PE	Paslanmaz Çelik Etiket	Metal	19x90mm	100	1.300

Paslanmaz Çelik Kablo Bağları

- Kendiliğinden kilitlenebilir kafa tasarımı, kurulumu hızlandırır ve kablo bağı gövdesi boyunca herhangi bir boyda kilitlemeyi sağlar.
- Güçlü ve dayanıklı kablo bağlama yöntemini temin eder.
- Çok çeşitli iç mekân ve dış mekân uygulama alanlarında kullanılabilir.
- Pürüzsüz yüzeyi ve yuvarlatılmış uçları ile kablonun korunmasını ve çalışan kişinin güvenliğini garanti eder.
- Şebeke kablolarında en üst düzey desteği sağlar.
- Genel amaçlı uygulamalar için : 304 paslanmaz çelik

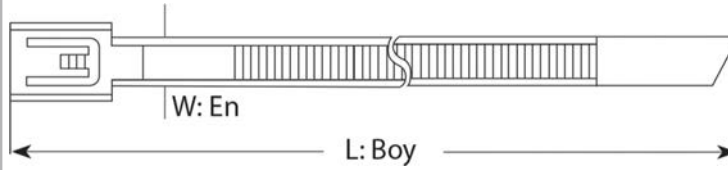

Malzeme : 304 Paslanmaz Çelik
Su emilimi : Yok
Alev yürme : UL94V-2

PVC KAPLI PASLANMAZ ÇELİK KABLO BAĞLARI

Sipariş Kodu	Ürün Kodu	Boyutlar		Renk	Maksimum Sıkma Çapı (mm)	Açılma Mukavemeti (kg)	Ambalaj Adet		Birim Fiyat TL / Adet
		Uzunluk (mm)	En (mm)				Paket	Koli	
1401	PVC MTL 150 ST	150	4.6	Metal	44	55	100	8.000	1.200
1402	PVC MTL 200 ST	200		Metal	51		100	6.000	1.350
1403	PVC MTL 260 ST	260		Metal	69		100	5.000	1.450
1404	PVC MTL 300 ST	300		Metal	76		100	5.000	1.750
1405	PVC MTL 370 ST	370		Metal	102		100	4.000	1.850
1406	PVC MTL 520 ST	520		Metal	152		100	3.000	2.300
1407	PVC MTL 680 ST	680		Metal	203		100	2.000	3.000
1408	PVC MTL 840 ST	840		Metal	254		100	1.000	4.200
1409	PVC MTL 200 HD	200	7.9	Metal	50	120	100	5.000	1.900
1410	PVC MTL 300 HD	300		Metal	75		100	4.000	2.400
1411	PVC MTL 370 HD	370		Metal	102		100	3.000	2.700
1412	PVC MTL 520 HD	520		Metal	152		100	2.000	3.600
1413	PVC MTL 680 HD	680		Metal	203		100	2.000	4.400
1414	PVC MTL 840 HD	840		Metal	224		100	1.000	5.400

PVC Kaplı Paslanmaz Çelik Kablo Bağları

- Kendiliğinden kilitlenebilir kafa tasarımı, kurulumu hızlandırır ve kablo bağı gövdesi boyunca herhangi bir boyda kilitlemeyi sağlar.
- Güçlü ve dayanıklı kablo bağlama yöntemini temin eder.
- Çok çeşitli iç mekân ve dış mekân uygulama alanlarında kullanılabilir.
- Pürüzsüz yüzeyi ve yuvarlatılmış uçları ile kablunun korunmasını ve çalışan kişinin güvenliğini garanti eder.
- Şebeke kablolarında en üst düzey desteği sağlar.
- Genel amaçlı uygulamalar için : 304 paslanmaz çelik



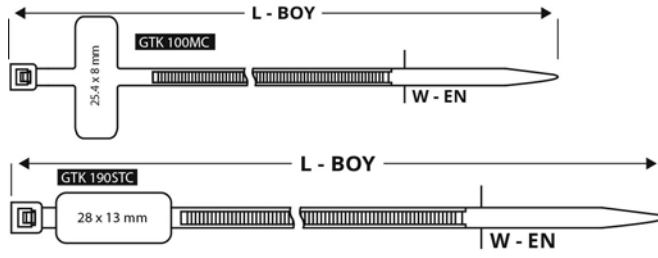

Malzeme :

Saf Naylon 6.6 Standart UL

Çalışma Sıcaklığı :

- 40 °C --- +85 °C

ETİKETLİ KABLO BAĞLARI

Sipariş Kodu	Ürün Kodu	Boyutlar		Renk	Maksimum Sıkma Çapı (mm)	Açılma Mukavemeti (kg)	Ambalaj Adet		Birim Fiyat TL / Adet
		Uzunluk (mm)	En (mm)				Paket	Koli	
1501	GTK 100 MC	100	2.5	Beyaz	20	8	100	30.000	0.115
1502	GTK 190 STC	190	4.8	Beyaz	48	22	100	12.000	0.300

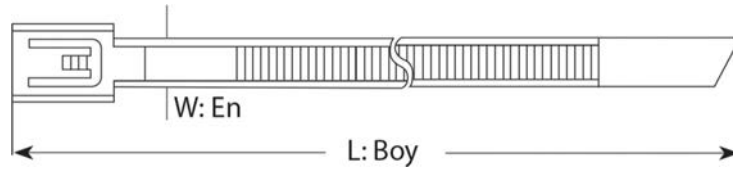

Malzeme :

Saf Naylon 6.6 Standart UL

Çalışma Sıcaklığı :

- 40 °C --- +85 °C

AÇILABİLİR KABLO BAĞLARI

Sipariş Kodu	Ürün Kodu	Boyutlar		Renk	Maksimum Sıkma Çapı (mm)	Açılma Mukavemeti (kg)	Ambalaj Adet		Birim Fiyat TL / Adet
		Uzunluk (mm)	En (mm)				Paket	Koli	
1503	GTA 200 HD	200	7.6	Beyaz	50	36	100	5.000	0.420
1504	GTA 370 HD	370	7.6	Beyaz	100	36	100	3.000	0.680570

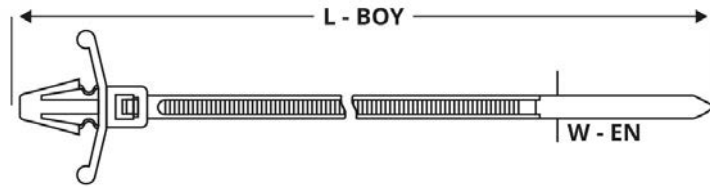

Malzeme :

Saf Naylon 6.6 Standart UL

Çalışma Sıcaklığı :

- 40 °C --- +85 °C

DİSTANSLI KABLO BAĞLARI

Sipariş Kodu	Ürün Kodu	Boyutlar		Renk	Maksimum Sıkma Çapı (mm)	Açılma Mukavemeti (kg)	Ambalaj Adet		Birim Fiyat TL / Adet
		Uzunluk (mm)	En (mm)				Paket	Koli	
1505	GTP 100 M	100	2.5	Beyaz	20	8	100	50.000	0.105
1506	GTP 150 I	150	3.6	Beyaz	35	18	100	30.000	0.170
1507	GTP 200 ST	200	4.8	Beyaz	50	22	100	12.000	0.320

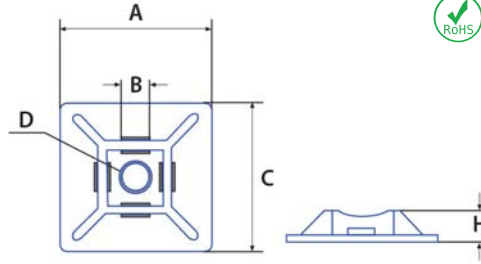

Malzeme :

Saf Naylon 6.6 Standart UL

Çalışma Sıcaklığı :

- 40 ° C --- +85 ° C

YAPIŞKANLI KROŞELER

Sipariş Kodu	Ürün Kodu	Boyutlar					Renk	Ambalaj Adet		Birim Fiyat TL / Adet
		A	B	C	D	H		Paket	Koli	
1513	HW - 3A	19	19	3.6	Ø 3.2	4.0	Beyaz	100	20.000	0.230
1514	HW - 4A	28	28	4.8	Ø 3.2	4.5	Beyaz	100	9.000	0.420
1515	HW - 3AB	19	19	3.6	Ø 3.2	4.0	Siyah	100	20.000	0.230
1516	HW - 4AB	28	28	4.8	Ø 3.2	4.5	Siyah	100	9.000	0.420

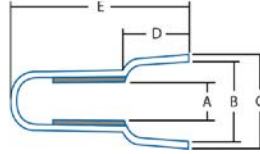
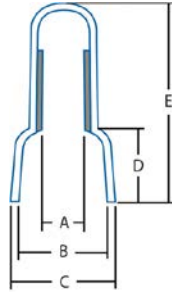

Malzeme :

Saf Naylon 6.6 Standart UL

Çalışma Sıcaklığı :

105 ° C --- +300 ° C

Modeli:

600 Volt Enerjiye Dayanabilme

KAPAMA PARÇASI

Sipariş Kodu	Ürün Kodu	Boyutlar					Renk	Ambalaj Adet		Birim Fiyat TL / Adet
		A	B	C	D	H		Paket	Koli	
1517	HW - C4	19	19	3.6	Ø 3.2	4.0	Beyaz	100	20.000	0.105
1518	HW - C5	28	28	4.8	Ø 3.2	4.5	Beyaz	100	9.000	0.180

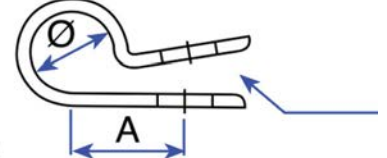
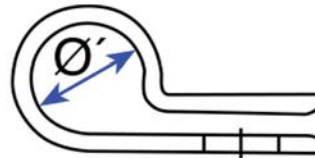
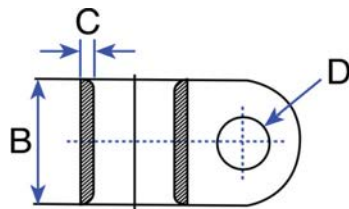

KABLO KELEPÇESİ

Sipariş Kodu	Ürün Kodu	Boyutlar						Renk	Ambalaj Adet		Birim Fiyat TL / Adet
		Ø	Ø 1	A	B	C	D		Paket	Koli	
1523	GCL 1/4	7.4	6.6	10.3	9.1	1.27	M5	Beyaz	100	30.000	0.190
1524	GCL 3/8	10.9	9.7	11.9	9.2	1.27	M5	Beyaz	100	20.000	0.240

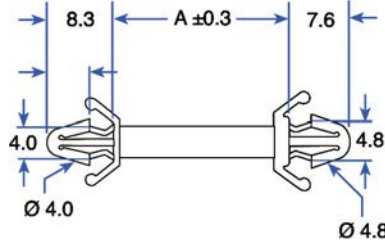
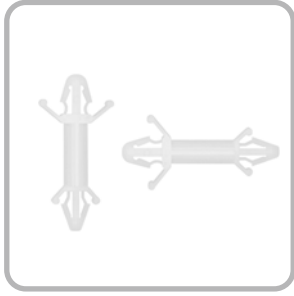

Malzeme :

Saf Naylon 6.6 Standart UL

Çalışma Sıcaklığı :

- 40 ° C --- +85 ° C

KARTUŞ YÜKSELTİCİ

Sipariş Kodu	Ürün Kodu	Boyutlar		Renk	Ambalaj Adet		Birim Fiyat TL / Adet
		A			Paket	Koli	
1519	CBS - 9A	9.2		Beyaz	1.000	40.000	0.230
1520	CBS - 13A	12.6		Beyaz	1.000	30.000	0.240
1521	CBS - 16A	15.8		Beyaz	1.000	25.000	0.270

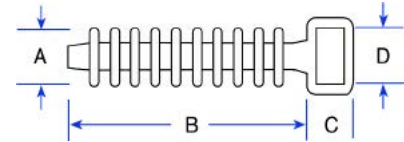

BETON KROŞE

Sipariş Kodu	Ürün Kodu	Boyutlar				Maksimum Sıkma Çapı (mm)	Renk	Ambalaj Adet		Birim Fiyat TL / Adet
		A	B	C	D			Paket	Koli	
1525	TH - 2	9.5	36.0	6.0	9.5	9.5	Siyah	100	8.000	0.300

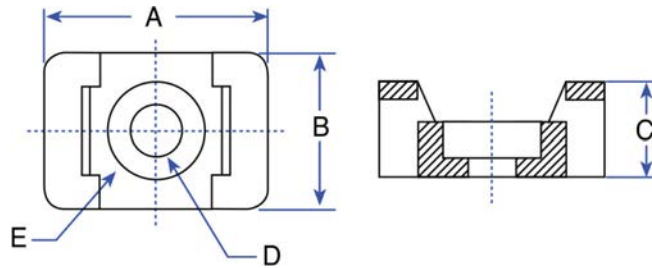

VİDALI KROŞE

Sipariş Kodu	Ürün Kodu	Boyutlar					Maksimum Sıkma Çapı (mm)	Renk	Ambalaj Adet		Birim Fiyat TL / Adet
		A	B	C	D	E			Paket	Koli	
1511	VK V - 1	14.9	9.5	6.9	4.5	7.8	4.8	Beyaz	100	5.000	0.165
1512	VK V - 2	22.2	15.9	9.7	6.4	12.6	7.6	Beyaz	100	5.000	0.240

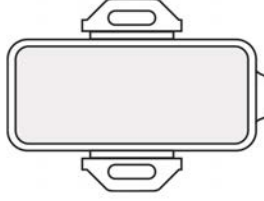

Malzeme :

Polipropilen

Çalışma Sıcaklığı :

0 °C --- +90 °C

KABLO BAĞI ETİKET TAŞIYICI

Sipariş Kodu	Ürün Kodu	Boyutlar			Etiket Eni (mm)	Etiket Boyu (mm)	Renk	Ambalaj Adet		Birim Fiyat TL / Adet
		A	B	C				Paket	Koli	
1526	GET - 1	35	10	8	32	7	Beyaz	100	12.500	0.530
1527	GET - 2	45	20	8	42	17	Beyaz	100	6.000	0.830



Malzeme :

ABS Altlık, PS Kapak + Çift Taraflı Bant

Çalışma Sıcaklığı :

-40 °C --- +60 °C

YAPIŞKANLI PANO ETİKET TAŞIYICI

Sipariş Kodu	Ürün Kodu	Boyutlar		Etiket Eni (mm)	Etiket Boyu (mm)	Renk	Ambalaj Adet		Birim Fiyat TL / Adet
		A	B				Paket	Koli	
1528	GPET - 1	30	17	27.5	14.4	Siyah	100	12.000	0.680
1529	GPET - 2	50	17	49	15	Siyah	50	6.000	0.920
1530	GPET - 3	75	17	72	15	Siyah	25	5.000	1.250

KABLO İŞARETLEME SİSTEMLERİ



BASKI NUMARASI	EC-0		EC-1		EC-2	
	KESİT: 0.50-1mm Kablolar için MAKARA : 1000 Ad.		KESİT: 1.50-6m Kablolar için MAKARA : 1000 Ad.		KESİT: 4-16mm Kablolar için MAKARA :500 Ad.	
	Sipariş Kodu	Fiyat	Sipariş Kodu	Fiyat	Sipariş Kodu	Fiyat
0	1601	23.00 TL	1611	23.00 TL	1621	23.00 TL
1	1602		1612		1622	
2	1603		1613		1623	
3	1604		1614		1624	
4	1605		1615		1625	
5	1606		1616		1626	
6	1607		1617		1627	
7	1608		1618		1628	
8	1609		1619		1629	
9	1610		1620		1630	

HELEZON SPİRALLER

Sipariş Kodu	Ürün Kodu	O.D.	T	W	Kablo Kesit (mm ²)	Renk	Paket Miktarı (Mt.)	Koli Miktarı (Mt.)	Birim Fiyat TL / Mt.
3251	GHS6 (No1)	6	0.60	7.4	2.5 - 15	Beyaz	10	1.000	1.10
3252	GHS8 (No2)	8	0.75	12	6 - 30	Beyaz	10	800	1.42
3253	GHS10 (No3)	10	0.80	12.3	7.5 - 30	Beyaz	10	500	2.20
3254	GHS12 (No4)	12	0.85	15	9 - 32	Beyaz	10	400	3.10
3255	GHS15 (No5)	15	1.00	15.5	12 - 35	Beyaz	10	250	4.00

Malzeme : PE

Esnek yapısı sayesinde kabloların düzenlemesine yardımcı olur
Güçlü yapısı sayesinde tekrar kullanım için uygundur

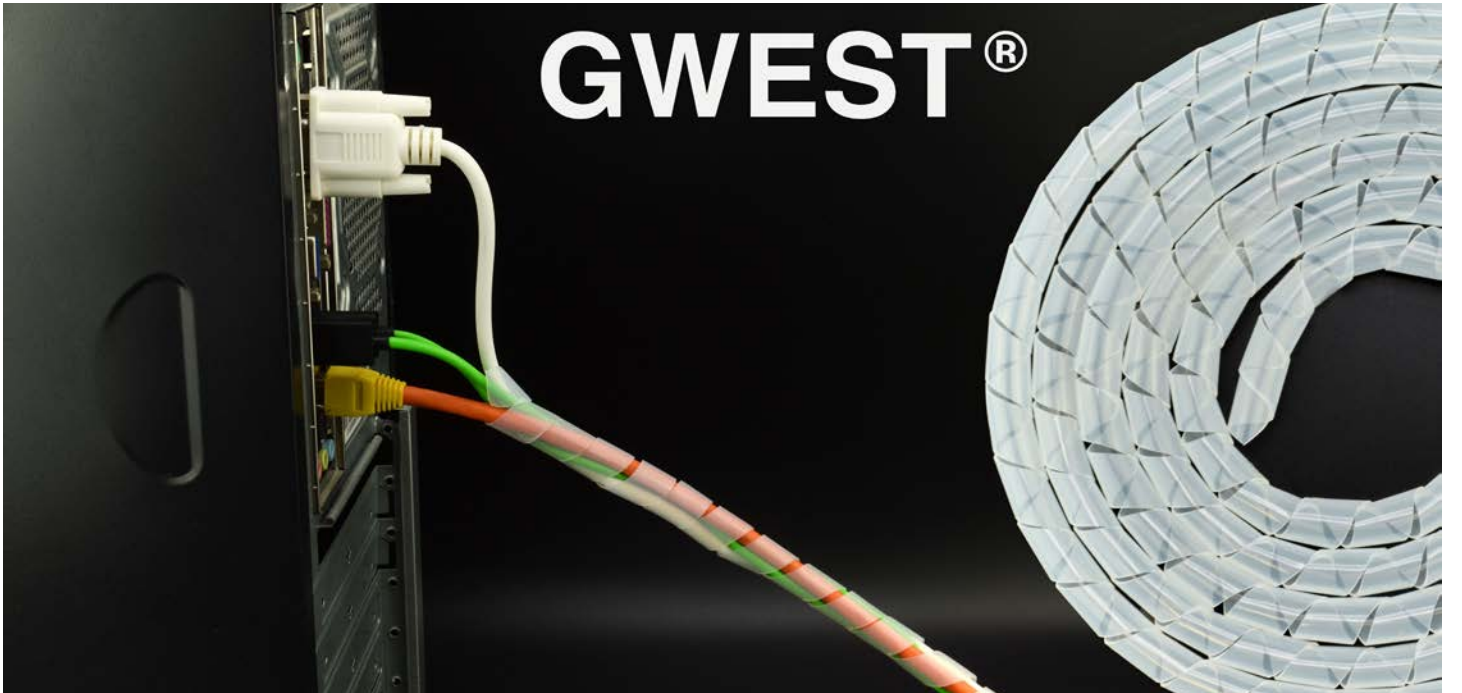
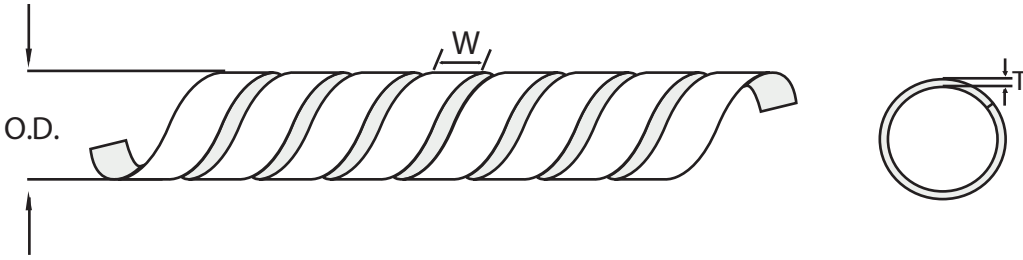



GÜVEN
ELEKTRİK ELEKTRONİK LTD. ŞTİ.

KABLO YÜKSÜKLERİ ve PAPUÇLARI



www.guvenelektrik.com.tr









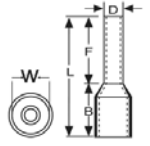







İZOLELİ KABLO YÜKSÜKLERİ FRANSIZ NORMU



Standart : DIN 46228
Malzeme : Bakır, Kalay Kaplı
İzolasyon : Naylon
Çalışma Sıcaklığı : Maksimum 105° 600Volt Arası



Sipariş Kodu	Ürün Kodu	Renk	Kablo Kesit (mm ²)	Ebatlar (mm)					Kutu Adet	Birim Fiyat TL / Adet
				F	L	W	B	D		
2001	IYF - 0.25	 Menekşe	0.25 mm ²	8.0	12.0	1.9	4.4	1.1	1.000	0.085
2002	IYF - 0.34	 Pembe	0.34 mm ²	8.0	12.0	1.9	4.4	1.1	1.000	0.085
2003	IYF - 0.50	 Beyaz	0.50 mm ²	8.0	14.0	2.6	6.0	1.3	1.000	0.040
2004	IYF - 0.75	 Mavi	0.75 mm ²	8.0	14.0	2.8	6.3	1.5	1.000	0.040
2005	IYF - 1.0	 Kırmızı	1.00 mm ²	8.0	14.0	3.0	6.3	1.7	1.000	0.040
2006	IYF - 1.5	 Siyah	1.50 mm ²	8.0	14.0	3.5	6.3	2.0	1.000	0.046
2007	IYF - 2.5	 Gri	2.50 mm ²	8.0	14.0	4.2	7.4	2.5	500	0.058
2008	IYF - 4.0	 Turuncu	4.00 mm ²	10.0	17.0	4.8	7.4	3.2	500	0.100
2009	IYF - 6.0	 Yeşil	6.00 mm ²	12.0	20.0	6.3	8.5	3.9	250	0.135
2010	IYF - 10.0	 Kahve	10.0 mm ²	12.0	22.0	7.6	8.8	4.9	100	0.170
2011	IYF - 16.0	 Bej	16.0 mm ²	12.0	24.0	8.8	10.0	6.2	100	0.240
2012	IYF - 25.0	 Siyah	25.0 mm ²	16.0	28.0	11.2	12.0	7.7	50	0.440
2013	IYF - 35.0	 Kırmızı	35.0 mm ²	16.0	30.0	12.7	14.0	8.7	50	0.530
2014	IYF - 50.0	 Mavi	50.0 mm ²	20.0	36.0	15.0	16.0	10.9	25	1.020
2015	IYF - 70.0	 Sarı	70.0 mm ²	21.0	37.0	16.0	17.0	14.3	25	1.900









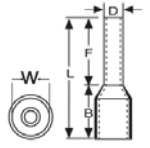



İZOLELİ KABLO YÜKSÜKLERİ ALMAN NORMU



Standart : DIN 46228
Malzeme : Bakır, Kalay Kaplı
İzolasyon : Naylon
Çalışma Sıcaklığı : Maksimum 105° 600Volt Arası



Sipariş Kodu	Ürün Kodu	Renk	Kablo Kesit (mm ²)	Ebatlar (mm)					Kutu Adet	Birim Fiyat TL / Adet
				F	L	W	B	D		
2101	IYA - 0.14	 Gri	0.14 mm ²	8.0	12.0	1.6	2.8	0.9	1.000	0.085
2102	IYA - 0.25	 Mavi	0.25 mm ²	8.0	12.0	1.9	4.4	1.1	1.000	0.085
2103	IYA - 0.34	 Turkuaz	0.34 mm ²	8.0	12.0	1.9	4.4	1.1	1.000	0.085
2104	IYA - 0.50	 Turuncu	0.50 mm ²	8.0	14.0	2.6	6.0	1.3	1.000	0.040
2105	IYA - 0.75	 Beyaz	0.75 mm ²	8.0	14.0	2.8	6.3	1.5	1.000	0.040
2106	IYA - 1.0	 Sarı	1.00 mm ²	8.0	14.0	3.0	6.3	1.7	1.000	0.040
2107	IYA - 1.5	 Kırmızı	1.50 mm ²	8.0	14.0	3.5	6.3	2.0	1.000	0.046
2108	IYA - 2.5	 Mavi	2.50 mm ²	8.0	14.0	4.2	7.4	2.5	500	0.058
2109	IYA - 4.0	 Gri	4.00 mm ²	10.0	17.0	4.8	7.4	3.2	500	0.100
2110	IYA - 6.0	 Siyah	6.00 mm ²	12.0	20.0	6.3	8.5	3.9	250	0.135
2111	IYA - 10.0	 Bej	10.0 mm ²	12.0	22.0	7.6	8.8	4.9	100	0.170
2112	IYA - 16.0	 Yeşil	16.0 mm ²	12.0	24.0	8.8	10.0	6.2	100	0.240
2113	IYA - 25.0	 Kahve	25.0 mm ²	16.0	28.0	11.2	12.0	7.7	50	0.440
2114	IYA - 35.0	 Bej	35.0 mm ²	16.0	30.0	12.7	14.0	8.7	50	0.530
2115	IYA - 50.0	 Yeşil	50.0 mm ²	20.0	36.0	15.0	16.0	10.9	25	1.020









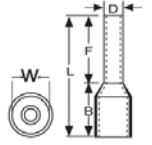

ÇİFT GİRİŞLİ KABLO YÜKSÜKLERİ FRANSIZ NORMU



Standart : DIN 46228
Malzeme : Bakır, Kalay Kaplı
İzolasyon : Naylon
Çalışma Sıcaklığı : Maksimum 105° 600Volt Arası



Sipariş Kodu	Ürün Kodu	Renk	Kablo Kesit (mm ²)	Ebatlar (mm)					Kutu Adet	Birim Fiyat TL / Adet
				F	L	W	B	D		
2201	CYF - 0.50	 Beyaz	0.50 mm ²	8.0	14.0	5.0	6.5	1.8	1.000	0.080
2202	CYF - 0.75	 Mavi	0.75 mm ²	8.0	14.0	5.5	6.7	2.1	500	0.080
2203	CYF - 1.0	 Kırmızı	1.00 mm ²	8.0	14.0	5.5	7.1	2.4	500	0.085
2204	CYF - 1.5	 Siyah	1.50 mm ²	8.0	14.0	6.4	7.5	2.6	500	0.103
2205	CYF - 2.5	 Gri	2.50 mm ²	10.0	14.0	8.0	8.5	3.3	250	0.165
2206	CYF - 4.0	 Turuncu	4.00 mm ²	12.0	17.0	8.0	11.1	4.2	200	0.195
2207	CYF - 6.0	 Yeşil	6.00 mm ²	14.0	20.0	9.5	12.1	5.3	100	0.260
2208	CYF - 10.0	 Kahve	10.0 mm ²	14.0	27.0	12.6	12.6	6.9	50	0.375
2209	CYF - 16.0	 Bej	16.0 mm ²	14.0	31.0	19.0	17.3	8.7	50	0.480









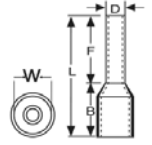

ÇİFT GİRİŞLİ KABLO YÜKSÜKLERİ ALMAN NORMU



Standart : DIN 46228
 Malzeme : Bakır, Kalay Kaplı
 İzolasyon : Naylon
 Çalışma Sıcaklığı : Maksimum 105° 600Volt Arası



Sipariş Kodu	Ürün Kodu	Renk	Kablo Kesit (mm ²)	Ebatlar (mm)					Kutu Adet	Birim Fiyat TL / Adet
				F	L	W	B	D		
2301	CYA - 0.50	 Turuncu	0.50 mm ²	8.0	14.0	5.0	6.5	1.8	1.000	0.080
2302	CYA - 0.75	 Beyaz	0.75 mm ²	8.0	14.0	5.5	6.7	2.1	500	0.080
2303	CYA - 1.0	 Sarı	1.00 mm ²	8.0	14.0	5.5	7.1	2.4	500	0.085
2304	CYA - 1.5	 Kırmızı	1.50 mm ²	8.0	14.0	6.4	7.5	2.6	500	0.103
2305	CYA - 2.5	 Mavi	2.50 mm ²	10.0	14.0	8.0	8.5	3.3	250	0.165
2306	CYA - 4.0	 Gri	4.00 mm ²	12.0	17.0	8.0	11.1	4.2	200	0.195
2307	CYA - 6.0	 Siyah	6.00 mm ²	14.0	20.0	9.5	12.1	5.3	100	0.260
2308	CYA - 10.0	 Bej	10.0 mm ²	14.0	27.0	12.6	12.6	6.9	50	0.375
2309	CYA - 16.0	 Yeşil	16.0 mm ²	14.0	31.0	19.0	17.3	8.7	50	0.480



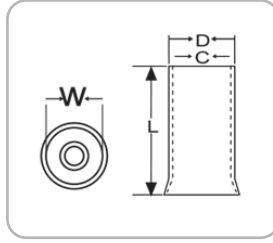

Standart : DIN 46228

Malzeme : Bakır, Kalay Kaplı

İZOLESİZ KABLO YÜKSÜKLERİ

Sipariş Kodu	Ürün Kodu	Kablo Kesit (mm ²)	Ebatlar (mm)				Kutu Adet	Birim Fiyat TL / Adet
			L	W	D	C		
2401	KY - 0.50	0.50 mm ²	10	2.1	1.3	1.0	2.000	0.040
2402	KY - 0.75	0.75 mm ²	10	2.3	1.5	1.2	1.000	0.040
2403	KY - 1.0	1.00 mm ²	10	2.5	1.7	1.4	1.000	0.040
2404	KY - 1.5	1.50 mm ²	10	2.8	2.0	1.7	1.000	0.046
2405	KY - 2.5	2.50 mm ²	12	3.4	2.5	2.2	1.000	0.065
2406	KY - 4.0	4.00 mm ²	12	4.0	3.2	2.8	1.000	0.090
2407	KY - 6.0	6.00 mm ²	12	4.7	3.9	3.5	500	0.120
2408	KY - 10.0	10.0 mm ²	15	5.8	4.9	4.5	250	0.195
2409	KY - 16.0	16.0 mm ²	15	7.5	6.2	5.8	250	0.270
2410	KY - 25.0	25.0 mm ²	16	9.1	7.9	7.5	100	0.370
2411	KY - 35.0	35.0 mm ²	16	10.2	8.7	8.3	100	0.420
2412	KY - 50.0	50.0 mm ²	22	12.7	10.9	10.3	50	0.820



GWEST®

KABLO UÇLARI

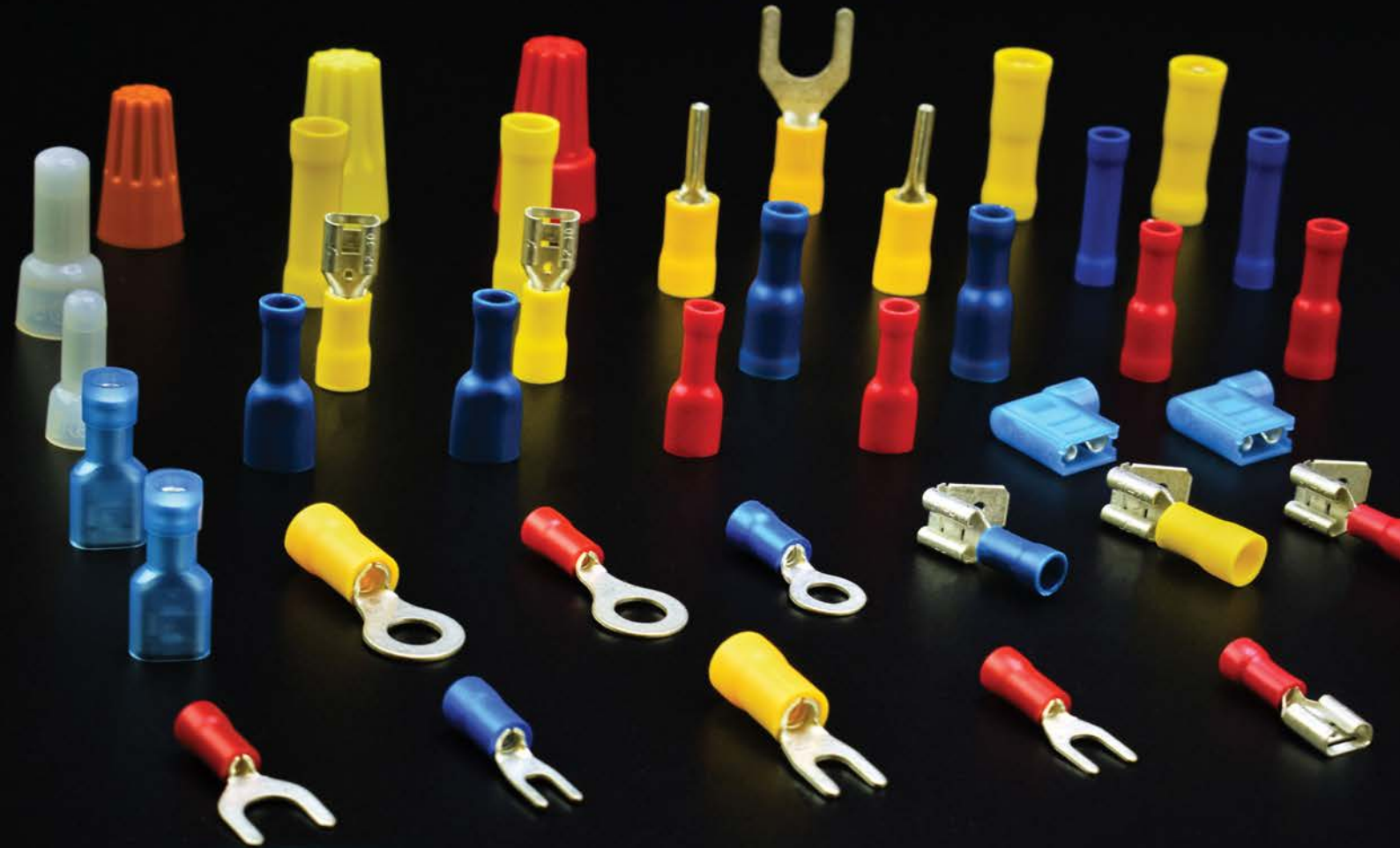

YUVARLAK TİP İZOLELİ KABLO UÇLARI

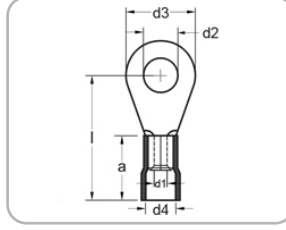

Standart : DIN 46237
Malzeme : Bakır, Kalay Kaplı
İzolasyon : PVC
Çalışma Sıcaklığı : Maksimum 105° 600Volt Arası

Sipariş Kodu	Ürün Kodu	Renk	Kablo Kesit (mm ²)	Civata Ölçüsü	Ebatlar (mm)						Kutu Adet	Birim Fiyat TL / Adet
					d2	d3	l	d1	d4	a		
3001	GYU - 301	Kırmızı	0.50 - 1.50 mm ²	M3	3.2	6.0	16.0	1.6	4.0	10.0	200	0.120
3003	GYU - 401	Kırmızı		M4	4.3	8.0	17.0	1.6	4.0	10.0	200	0.185
3004	GYU - 501	Kırmızı		M5	5.3	10.0	18.0	1.6	4.0	10.0	200	0.187
3005	GYU - 601	Kırmızı		M6	6.5	10.0	18.0	1.6	4.0	10.0	200	0.295
3006	GYU - 801	Kırmızı		M8	8.4	14.0	22.0	1.6	4.0	10.0	200	0.300
3007	GYU - 302	Mavi	1.50 - 2.50 mm ²	M3	3.2	6.0	16.0	2.3	4.5	10.0	200	0.220
3008	GYU - 402	Mavi		M4	4.3	8.0	17.0	2.3	4.5	10.0	200	0.230
3009	GYU - 502	Mavi		M5	5.3	10.0	19.0	2.3	4.5	10.0	200	0.235
3010	GYU - 602	Mavi		M6	6.5	11.0	20.0	2.3	4.5	10.0	200	0.325
3011	GYU - 802	Mavi		M8	8.4	14.0	22.0	2.3	4.5	10.0	200	0.330
3012	GYU - 1002	Mavi		M10	10.5	15.0	22.0	2.3	4.5	10.0	200	0.340
3013	GYU - 406	Sarı	4.00 - 6.00 mm ²	M4	4.3	8.6	21.0	3.6	6.3	13.0	100	0.475
3014	GYU - 506	Sarı		M5	5.3	10.0	22.0	3.6	6.3	13.0	100	0.480
3015	GYU - 606	Sarı		M6	6.5	11.0	22.5	3.6	6.3	13.0	100	0.540
3016	GYU - 806	Sarı		M8	8.4	14.0	26.0	3.6	6.3	13.0	100	0.690
3017	GYU - 1006	Sarı		M10	10.5	18.0	28.0	3.6	6.3	13.0	100	0.700
3018	GYU - 1206	Sarı		M12	13.0	18.0	28.0	3.6	6.3	13.0	100	0.710
3019	GYU - 610	Kırmızı	8.00 - 10.00 mm ²	M6	6.7	23.5	30.0	4.5	8.0	17.0	50	1.150
3020	GYU - 810	Kırmızı		M8	8.4	26.3	36.0	4.5	8.0	17.0	50	1.250

ÇATAL TİP İZOLELİ KABLO UÇLARI

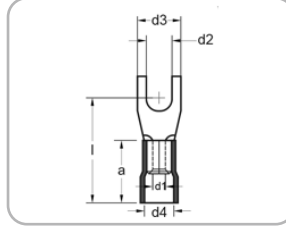

Standart : DIN 46237
Malzeme : Bakır, Kalay Kaplı
İzolasyon : PVC
Çalışma Sıcaklığı : Maksimum 105° 600Volt Arası

Sipariş Kodu	Ürün Kodu	Renk	Kablo Kesit (mm ²)	Civata Ölçüsü	Ebatlar (mm)						Kutu Adet	Birim Fiyat TL / Adet
					d2	d3	l	d1	d4	a		
3101	GÇU - 3001	Kırmızı	0.50 - 1.50 mm ²	M3	3.2	6.0	16.0	1.6	4.0	10.0	200	0.165
3102	GÇU - 4001	Kırmızı		M4	4.3	8.0	17.0	1.6	4.0	10.0	200	0.175
3103	GÇU - 5001	Kırmızı		M5	5.3	10.0	18.0	1.6	4.0	10.0	200	0.182
3104	GÇU - 6001	Kırmızı		M6	6.5	11.0	20.0	1.6	4.0	10.0	200	0.200
3105	GÇU - 3002	Mavi	1.50 - 2.50 mm ²	M3	3.2	5.5	18.0	2.3	4.5	10.0	200	0.185
3106	GÇU - 4002	Mavi		M4	4.3	6.8	17.0	2.3	4.5	10.0	200	0.190
3107	GÇU - 5002	Mavi		M5	5.3	10.0	19.0	2.3	4.5	10.0	200	0.192
3108	GÇU - 6002	Mavi		M6	6.5	11.0	21.0	2.3	4.5	10.0	200	0.260
3109	GÇU - 4006	Sarı	4.00 - 6.00 mm ²	M4	4.3	8.0	21.0	3.6	6.3	13.0	100	0.410
3110	GÇU - 5006	Sarı		M5	5.3	10.0	22.0	3.6	6.3	13.0	100	0.415
3111	GÇU - 6006	Sarı		M6	6.5	11.0	23.0	3.6	6.3	13.0	100	0.560
3112	GÇU - 8006	Sarı		M8	8.4	14.0	26.0	3.6	6.3	13.0	100	0.650

EK MUFLARI İZOLELİ KABLO UÇLARI



Standart : DIN 46237
Malzeme : Bakır, Kalay Kaplı
İzolasyon : PVC
Çalışma Sıcaklığı : Maksimum 75° 300Volt Arası

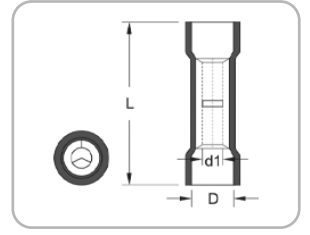

Sipariş Kodu	Ürün Kodu	Renk	Kablo Kesit (mm ²)	Ebatlar (mm)			Kutu Adet	Birim Fiyat TL / Adet
				L	D	d1		
3201	GBY - 251	■ Kırmızı	0.50 - 1.50 mm ²	24.6	4.0	1.7	200	0.255
3202	GBY - 252	■ Mavi	1.50 - 2.50 mm ²	24.6	4.5	2.3	200	0.280
3203	GBY - 256	■ Sarı	4.00 - 6.00 mm ²	26.5	6.3	3.4	100	0.450

ERKEK TERMİNALLER İZOLELİ KABLO UÇLARI



Malzeme : Pirinç, Kalay Kaplı, Bakır Yüksüklü
İzolasyon : PVC
Çalışma Sıcaklığı : Maksimum 75° 300Volt Arası

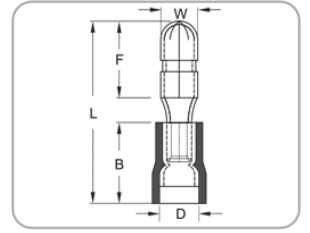

Sipariş Kodu	Ürün Kodu	Renk	Kablo Kesit (mm ²)	Ebatlar (mm)					Kutu Adet	Birim Fiyat TL / Adet
				W	F	L	B	D		
3204	GBE - 1040	■ Kırmızı	0.50 - 1.50 mm ²	4.0	8.5	21.5	10.5	3.8	200	0.450
3205	GBE - 2050	■ Mavi	1.50 - 2.50 mm ²	5.0	8.5	21.2	10.5	4.7	200	0.530
3206	GBE - 5050	■ Sarı	4.00 - 6.00 mm ²	5.0	8.5	24.0	13.0	6.2	200	0.700

DİŞİ TERMİNALLER İZOLELİ KABLO UÇLARI



Malzeme : Pirinç, Kalay Kaplı, Bakır Yüksüklü
İzolasyon : PVC
Çalışma Sıcaklığı : Maksimum 75° 300Volt Arası

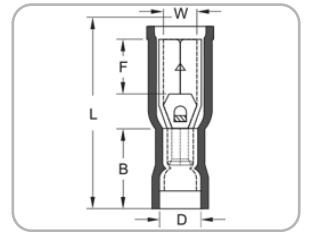

Sipariş Kodu	Ürün Kodu	Renk	Kablo Kesit (mm ²)	Ebatlar (mm)					Kutu Adet	Birim Fiyat TL / Adet
				W	F	L	B	D		
3207	GBD - 1040	■ Kırmızı	0.50 - 1.50 mm ²	3.9	7.0	23.3	10.5	3.8	200	0.540
3208	GBD - 2050	■ Mavi	1.50 - 2.50 mm ²	4.9	7.0	23.3	10.5	4.7	100	0.600
3209	GBD - 5050	■ Sarı	4.00 - 6.00 mm ²	4.9	7.0	25.1	12.5	6.2	100	0.780

DIŞİ FASTON TİP İZOLELİ KABLO UÇLARI



Malzeme : Pirinç, Kalay Kaplı
İzolasyon : PVC
Çalışma Sıcaklığı : Maksimum 75° 300Volt Arası

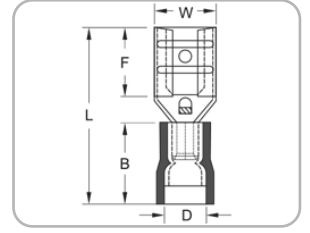

Sipariş Kodu	Ürün Kodu	Renk	Kablo Kesit (mm ²)	Soket Genişliği	Ebatlar (mm)					Kutu Adet	Birim Fiyat TL / Adet
					W	F	L	B	D		
3210	GFD - 1288	■ Kırmızı	0.50 - 1.50 mm ²	0.8 x 2.80	3.2	6.5	19.0	10.5	3.8	200	0.200
3211	GFD - 1488	■ Kırmızı		0.8 x 4.75	5.0	6.4	19.4	10.5	3.8	200	0.250
3212	GFD - 1638	■ Kırmızı		0.8 x 6.35	6.6	7.5	20.8	10.5	3.8	200	0.325
3213	GFD - 2288	■ Mavi	1.50 - 2.50 mm ²	0.8 x 2.80	3.2	6.5	19.0	10.5	4.7	200	0.250
3214	GFD - 2488	■ Mavi		0.8 x 4.75	5.0	6.4	19.4	10.5	4.7	200	0.290
3215	GFD - 2638	■ Mavi		0.8 x 6.35	6.6	7.5	20.8	10.5	4.7	200	0.325
3216	GFD - 5638	■ Sarı	4.00 - 6.00 mm ²	0.8 x 6.35	6.6	7.5	23.3	13.0	6.2	200	0.390

TAM İZOLELİ DIŞİ FASTON TİP KABLO UÇLARI



Malzeme : Pirinç, Kalay Kaplı
İzolasyon : PVC
Çalışma Sıcaklığı : Maksimum 75° 300Volt Arası

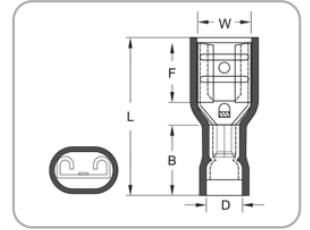

Sipariş Kodu	Ürün Kodu	Renk	Kablo Kesit (mm ²)	Soket Genişliği	Ebatlar (mm)					Kutu Adet	Birim Fiyat TL / Adet
					W	F	L	B	D		
3218	GFFD - 1288	■ Kırmızı	0.50 - 1.50 mm ²	0.8 x 2.80	3.2	6.5	19.0	10.5	3.8	200	0.300
3219	GFFD - 1488	■ Kırmızı		0.8 x 4.75	5.0	6.4	20.5	10.5	3.8	200	0.300
3220	GFFD - 1638	■ Kırmızı		0.8 x 6.35	6.6	7.5	21.8	10.5	3.8	200	0.430
3221	GFFD - 2288	■ Mavi	1.50 - 2.50 mm ²	0.8 x 2.80	3.2	6.5	20.0	10.5	4.7	200	0.310
3222	GFFD - 2488	■ Mavi		0.8 x 4.75	5.0	6.4	20.2	10.5	4.7	200	0.310
3223	GFFD - 2638	■ Mavi		0.8 x 6.35	6.6	7.5	22.2	10.5	4.7	200	0.430
3224	GFFD - 5638	■ Sarı	4.00 - 6.00 mm ²	0.8 x 6.35	6.6	7.5	24.2	12.5	6.2	100	0.460

TAM İZOLELİ POLYAMİD DIŞİ FASTON TİP KABLO UÇLARI



Malzeme : Pirinç, Kalay Kaplı
İzolasyon : Polyamid
Çalışma Sıcaklığı : Maksimum 105° 300Volt Arası

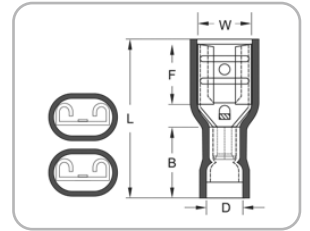

Sipariş Kodu	Ürün Kodu	Renk	Kablo Kesit (mm ²)	Soket Genişliği	Ebatlar (mm)					Kutu Adet	Birim Fiyat TL / Adet
					W	F	L	B	D		
3225	GPFD - 1638	■ Kırmızı	0.50 - 1.50 mm ²	0.8 x 6.35	6.6	7.5	21.5	11.0	4.0	200	0.900
3226	GPFD - 2638	■ Mavi	1.50 - 2.50 mm ²	0.8 x 6.35	6.6	7.5	21.5	11.0	5.0	200	0.900
3227	GPFD - 5638	■ Sarı	4.00 - 6.00 mm ²	0.8 x 6.35	6.6	7.5	24.2	13.0	6.5	100	1.100

İĞNE TİP İZOLELİ KABLO UÇLARI



Malzeme : Bakır, Kalay Kaplı
İzolasyon : PVC
Çalışma Sıcaklığı : Maksimum 75° 300Volt Arası

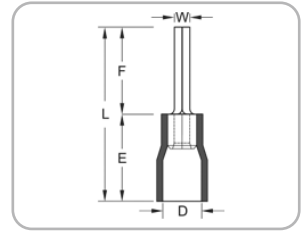

Sipariş Kodu	Ürün Kodu	Renk	Kablo Kesit (mm ²)	Ebatlar (mm)					Kutu Adet	Birim Fiyat TL / Adet
				W	F	L	E	D		
3228	GİK - 101	■ Kırmızı	0.50 - 1.50 mm ²	1.9	10.0	19.0	10.0	4.0	200	0.200
3229	GİK - 102	■ Mavi	1.50 - 2.50 mm ²	1.9	12.0	21.8	10.0	4.5	200	0.235
3230	GİK - 106	■ Sarı	4.00 - 6.00 mm ²	2.8	14.0	27.0	27.0	6.4	100	0.560

ERKEK / DIŞİ GERİ DÖNÜŞLÜ TERMİNALER



Malzeme : Pirinç, Kalay Kaplı
İzolasyon : PVC
Çalışma Sıcaklığı : Maksimum 75° 300Volt Arası

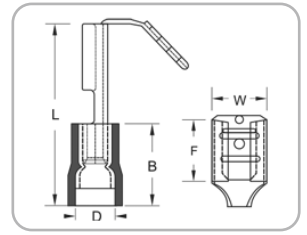

Sipariş Kodu	Ürün Kodu	Renk	Kablo Kesit (mm ²)	Soket Genişliği	Ebatlar (mm)					Kutu Adet	Birim Fiyat TL / Adet
					W	F	L	B	D		
3231	GFDEG - 1861	■ Kırmızı	0.50 - 1.50 mm ²	0.8 x 6.35	6.6	8.0	22.5	10.5	3.8	100	0.570
3232	GFDEG - 2862	■ Mavi	1.50 - 2.50 mm ²	0.8 x 6.35	6.6	8.0	22.5	10.5	4.7	100	0.570
3233	GFDEG - 5866	■ Sarı	4.00 - 6.00 mm ²	0.8 x 6.35	6.6	8.0	24.0	13.0	6.2	100	0.620

TAM İZOLELİ POLYAMİD BAYRAK TİP TERMİNALER



Malzeme : Pirinç, Kalay Kaplı
İzolasyon : Polyamid
Çalışma Sıcaklığı : Maksimum 105° 300Volt Arası

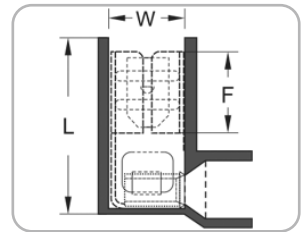

Sipariş Kodu	Ürün Kodu	Renk	Kablo Kesit (mm ²)	Ebatlar (mm)			Kutu Adet	Birim Fiyat TL / Adet
				W	F	L		
3234	GPFDEB - 1861	■ Kırmızı	0.8 x 6.35	6.6	7.6	16.0	100	0.570
3235	GPFDEB - 2862	■ Mavi	0.8 x 6.35	6.6	7.6	16.0	100	0.570

ERKEK FASTON TİP TERMİNALLER



Malzeme : Pirinç, Kalay Kaplı
İzolasyon : PVC
Çalışma Sıcaklığı : Maksimum 75° 300Volt Arası

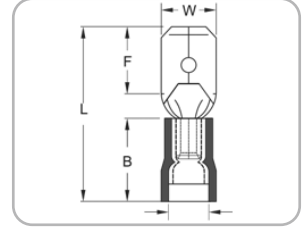

Sipariş Kodu	Ürün Kodu	Renk	Kablo Kesit (mm ²)	Soket Geniřlięi	Ebatlar (mm)					Kutu Adet	Birim Fiyat TL / Adet
					W	F	L	B	D		
3236	GFE - 1288	Kırmızı	0.50 - 1.50 mm ²	0.8 x 2.80	2.8	6.5	19.2	10.5	3.8	200	0.225
3237	GFE - 1488	Kırmızı		0.8 x 4.75	4.8	6.7	19.8	10.5	3.8	200	0.225
3238	GFE - 1638	Kırmızı		0.8 x 6.35	6.35	6.35	21.8	10.5	3.8	200	0.275
3239	GFE - 2288	Mavi	1.50 - 2.50 mm ²	0.8 x 2.80	2.8	6.7	19.8	10.5	4.7	200	0.225
3240	GFE - 2488	Mavi		0.8 x 4.75	4.8	6.7	19.8	10.5	4.7	200	0.225
3241	GFE - 2638	Mavi		0.8 x 6.35	6.35	7.7	21.8	10.5	4.7	200	0.290
3242	GFE - 5638	Sarı	4.00 - 6.00 mm ²	0.8 x 6.35	6.35	7.7	24.8	13.0	6.2	200	0.340

VİDALI BUAT KLEMENSLERİ



Malzeme : Pirinç, Kalay Kaplı
İzolasyon : PVC
Çalışma Sıcaklığı : Maksimum 75° 300Volt Arası

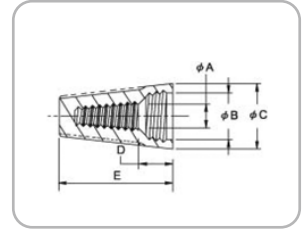

Sipariş Kodu	Ürün Kodu	Renk	Ebatlar (mm)					Kutu Adet	Birim Fiyat TL / Adet
			A	B	C	D	E		
3243	G - 1	Gri	3.8	6.70	8.60	5.80	15.20	1.000	0.190
3244	G - 2	Mavi	4.10	7.00	9.80	5.90	17.60	1.000	0.225
3245	G - 3	Oranj	5.00	9.90	12.20	7.80	22.00	500	0.300
3246	G - 4	Sarı	6.00	11.20	14.00	7.90	24.00	500	0.500
3247	G - 6	Kırmızı	7.50	13.00	16.40	9.15	26.50	500	0.620

HIZLI KABLO EKLEME PARÇASI



Malzeme : Pirinç, Kalay Kaplı
İzolasyon : Naylon
Çalışma Sıcaklığı : Maksimum 105° 600Volt Arası

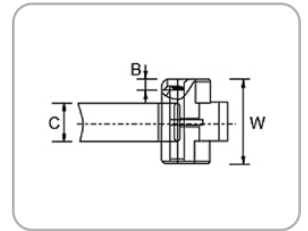

Sipariş Kodu	Ürün Kodu	Renk	Kablo Kesit (mm ²)	Ebatlar (mm)			Kutu Adet	Birim Fiyat TL / Adet
				W	F	L		
3248	GP - 1	Kırmızı	0.50 - 1.00 mm ²	4.0	10.6	20.0	500	0.430
3249	GP - 2	Mavi	1.50 - 2.50 mm ²	4.0	10.6	20.0	500	0.430
3250	GP - 5	Sarı	4.00 - 6.00 mm ²	4.0	2.0	20.0	250	0.700

İZOLESİZ KABLO UCU VE KONNEKTÖRLERİ

					
SİPARİŞ KODU	3301	3302	3303	3305	3304
ÜRÜN KODU	GF1/2D	GF1D MİNİ	GF1D	GF3D	GF2D TRK
AÇIKLAMA	2.8 Mikro Dişi Terminal	4.8 Mini Dişi Terminal	6.3 Dişi Terminal	9.5 Dişi Terminal	6.3 Tırnaklı Dişi Terminal
KUTU ADET	1.000	500	300	100	300
BİRİM FİYAT TL/Ad.	0.077	0.115	0.150	0.370	0.155

					
SİPARİŞ KODU	3306	3307	3320	3321	3309
ÜRÜN KODU	GF1D EĞRİ	GF1D E	GKN 1-03	GKN 1-04	GKN 2.5-04
AÇIKLAMA	6.3 Eğri Dişi Terminal	6.3 Erkek Geri Dönüşümlü Terminal	M3 Topraklama Terminali	M4 Topraklama Terminali	M4 Topraklama Terminali
KUTU ADET	250	200	500	500	500
BİRİM FİYAT TL/Ad.	0.180	0.300	0.115	0.115	0.125

					
SİPARİŞ KODU	3310	3311	3312	3313	3314
ÜRÜN KODU	GKN 2.5-05	GKN 2.5-06	GKN 4-04	GKN 4-05	GKN 4-06
AÇIKLAMA	M5 Topraklama Terminali	M6 Topraklama Terminali	M4 Topraklama Terminali	M5 Topraklama Terminali	M6 Topraklama Terminali
KUTU ADET	500	500	250	250	250
BİRİM FİYAT TL/Ad.	0.125	0.125	0.300	0.300	0.300

					
SİPARİŞ KODU	3315	3316	3318	3325	3326
ÜRÜN KODU	GKN 6-06	GKN 8-08	GKN 10-10	GK 2.5	GK 4
AÇIKLAMA	M6 Topraklama Terminali	M8 Topraklama Terminali	M10 Topraklama Terminali	Boru Tip Topraklama Terminali	Boru Tip Topraklama Terminali
KUTU ADET	150	150	100	1.000	500
BİRİM FİYAT TL/Ad.	0.390	0.390	0.475	0.150	0.260

					
SİPARİŞ KODU	3327	3332	3333	3341	3340
ÜRÜN KODU	GK 6	GF1E ÇK	GF1EU1	R TİPİ KONNEKTÖR	GF1D KILIF
AÇIKLAMA	Boru Tip Topraklama Terminali	6.3 Erkek Terminal	6.3 Uzun Erkek Terminal	6.3 Kilitli Konnektör	6.3 Terminal Kılıfı
KUTU ADET	250	300	300	300	300
BİRİM FİYAT TL/Ad.	0.285	0.150	0.195	0.082	0.075



GÜVEN
ELEKTRİK ELEKTRONİK LTD. ŞTİ.

BAĞLANTI ELEMENLARI

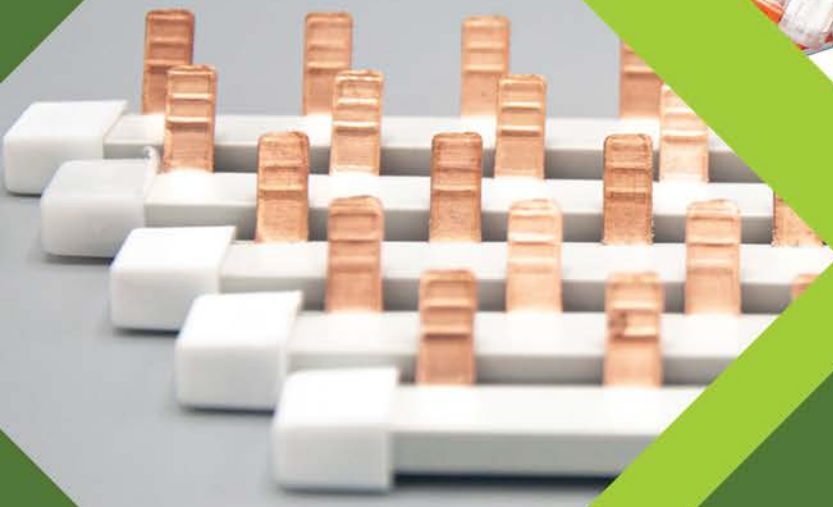

www.guvenelektrik.com.tr



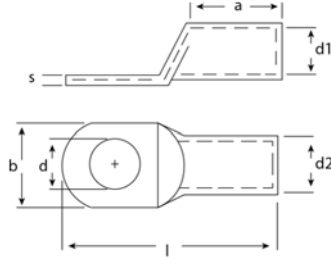

Malzeme : EN13600 Standart Bakır
Yüzey : Kalay

SKP-E EKONOMİK TİP KABLO PAPUCU

Sipariş Kodu	Ürün Kodu	Kablo Kesit (mm ²)	Delik Çapı Ø	Boyutlar						Kutu/Amb. Adet	Birim Fiyat TL / Adet
				d	d1	d2	l	a	b		
3400	SKP-E 16-6	16 mm ²	M6	6.5	5.5	7.0	32.5	11.0	10.5	500	1.05
3401	SKP-E 16-8	16 mm ²	M8	8.5	5.5	7.0	32.5	11.0	10.5	500	1.10
3402	SKP-E 25-6	25 mm ²	M6	6.5	7.0	9.0	38.5	16.0	13.0	400	2.00
3403	SKP-E 25-8		M8	8.5	7.0	9.0	38.5	16.0	13.0	400	1.90
3404	SKP-E 35-6	35 mm ²	M6	6.5	8.5	10.5	43.5	19.0	15.5	300	2.80
3405	SKP-E 35-8		M8	8.3	8.5	10.5	43.5	19.0	15.5	300	2.70
3406	SKP-E 50-8	50 mm ²	M8	8.5	10.0	12.0	51.5	21.0	17.6	200	3.20
3407	SKP-E 50-10		M10	10.5	10.0	12.0	51.5	21.0	17.6	200	3.10
3408	SKP-E 70-10	70 mm ²	M10	10.5	11.5	14.0	55.5	23.0	20.7	100	5.30
3409	SKP-E 70-12		M12	13.0	11.5	14.0	55.5	23.0	20.7	100	5.40
3410	SKP-E 95-10	95 mm ²	M10	10.5	13.5	16.0	58.5	26.0	23.5	75	6.30
3411	SKP-E 95-12		M12	13.0	13.5	16.0	58.5	26.0	23.5	75	6.20
3412	SKP-E 120-10	120 mm ²	M10	10.5	15.5	18.0	71.0	29.0	26.7	50	9.20
3413	SKP-E 120-12		M12	13.0	15.5	18.0	71.0	29.0	26.7	50	9.00
3414	SKP-E 150-10	150 mm ²	M10	10.5	16.5	20.0	76.0	30.0	29.2	40	13.80
3415	SKP-E 150-12		M12	13.0	16.5	20.0	76.0	30.0	29.2	40	13.50
3416	SKP-E 185-12	185 mm ²	M12	13.0	18.5	22.0	82.0	33.0	32.3	30	16.50
3417	SKP-E 185-16		M16	17.0	18.5	22.0	82.0	33.0	32.3	30	16.00
3418	SKP-E 240-12	240 mm ²	M12	13.0	21.5	25.5	91.0	38.0	37.6	25	24.50
3419	SKP-E 240-16		M16	17.0	21.5	25.5	91.0	38.0	37.6	25	24.00

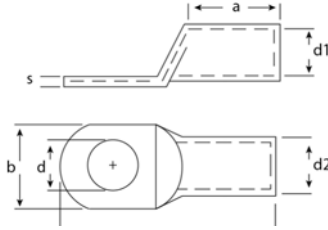

Malzeme : EN13600 Standart Bakır
Yüzey : Kalay

SKP-S STANDART TİP KABLO PAPUCU

Sipariş Kodu	Ürün Kodu	Kablo Kesit (mm ²)	Delik Çapı Ø	Boyutlar								Kutu/Amb. Adet	Birim Fiyat TL / Adet	
				d	d1	d2	l	l1	a	b	c1			c2
3430	SKP-S 10-5	10 mm ²	M5	5.5	4.4	6.0	27.5	21.6	10.0	10.3	6.0	6.0	1.000	1.25
3431	SKP-S 10-6		M6	6.5	4.4	6.0	27.5	21.6	10.0	10.3	6.0	6.0	1.000	1.25
3432	SKP-S 10-8		M8	8.5	4.4	6.0	27.5	21.6	10.0	13.5	6.0	6.0	1.000	1.25
3433	SKP-S 16-6	16 mm ²	M6	6.5	5.5	8.0	32.6	25.0	12.0	11.2	7.0	8.0	500	1.90
3434	SKP-S 16-8		M8	8.5	5.5	8.0	32.6	25.0	12.0	13.7	7.0	8.0	500	1.90
3435	SKP-S 16-10		M10	10.5	5.5	8.0	32.6	25.0	12.0	16.0	7.0	8.0	500	2.30
3436	SKP-S 25-6	25 mm ²	M6	6.5	6.8	9.0	39.0	32.2	16.0	13.5	6.8	9.2	400	3.10
3437	SKP-S 25-8		M8	8.5	6.8	9.0	39.0	32.2	16.0	13.5	6.8	9.2	400	3.00
3438	SKP-S 25-10		M10	10.5	7.0	9.5	42.0	34.0	16.0	16.0	6.8	11.0	300	3.10
3439	SKP-S 35-6	35 mm ²	M6	6.5	8.2	11.0	44.0	35.7	19.0	15.7	8.3	9.7	200	4.20
3440	SKP-S 35-8		M8	8.5	8.2	11.0	44.0	35.7	19.0	15.7	8.3	9.7	200	4.10
3441	SKP-S 35-10		M10	10.5	8.2	11.0	48.0	38.0	19.0	15.7	10.0	12.0	200	4.20
3442	SKP-S 50-8	50 mm ²	M8	8.5	9.5	12.0	47.5	39.2	21.0	17.7	8.3	9.7	150	6.60
3443	SKP-S 50-10		M10	10.5	9.5	12.0	51.5	41.5	21.0	17.7	10.0	12.0	150	6.50
3444	SKP-S 50-12		M12	13.0	10.1	13.0	51.5	41.5	21.0	19.0	10.0	12.0	150	6.60
3445	SKP-S 50-14		M14	15.0	10.1	13.0	56.5	44.5	21.0	20.5	12.0	15.0	150	6.60
3446	SKP-S 70-8	70 mm ²	M8	8.5	11.2	14.5	54.6	44.6	23.0	21.1	10.0	12.0	100	8.60
3447	SKP-S 70-10		M10	10.5	11.2	14.5	54.6	44.6	23.0	21.1	10.0	12.0	100	8.60
3448	SKP-S 70-12		M12	13.0	11.2	14.5	54.6	44.6	23.0	21.1	10.0	12.0	100	8.60
3449	SKP-S 70-14		M14	15.0	11.2	14.5	62.6	47.6	23.0	21.4	15.0	15.0	100	9.50
3450	SKP-S 95-8	95 mm ²	M8	8.5	13.4	17.0	58.8	48.8	26.0	24.5	10.0	12.0	75	9.20
3451	SKP-S 95-10		M10	10.5	13.4	17.0	58.8	48.8	26.0	24.5	10.0	12.0	75	9.20
3452	SKP-S 95-12		M12	13.0	13.4	17.0	58.8	48.8	26.0	24.5	10.0	12.0	75	9.20
3453	SKP-S 120-10	120 mm ²	M10	10.5	15.5	19.0	69.0	56.0	29.0	28.0	13.0	14.5	50	13.00
3454	SKP-S 120-12		M12	13.0	15.5	19.0	69.0	56.0	29.0	28.0	13.0	14.5	50	13.00
3455	SKP-S 120-16		M16	17.0	15.5	19.0	69.0	56.0	29.0	28.0	13.0	14.5	50	13.00
3456	SKP-S 150-10	150 mm ²	M10	10.5	16.5	21.0	76.5	60.0	30.0	30.0	16.5	16.5	40	20.00
3457	SKP-S 150-12		M12	13.0	16.5	21.0	76.5	60.0	30.0	30.0	16.5	16.5	40	20.00
3458	SKP-S 150-16		M16	17.0	16.5	21.0	76.5	60.0	30.0	30.0	16.5	16.5	40	20.00
3459	SKP-S 185-12	185 mm ²	M12	13.0	18.5	23.0	82.5	65.5	33.0	34.0	17.0	18.0	30	23.70
3460	SKP-S 185-16		M16	17.0	18.5	23.0	82.5	65.5	33.0	34.0	17.0	18.0	30	23.70
3461	SKP-S 240-12	240 mm ²	M12	13.0	21.0	26.0	89.0	72.0	38.0	38.0	17.0	18.0	25	32.00
3462	SKP-S 240-16		M16	17.0	21.0	26.0	89.0	72.0	38.0	38.0	17.0	18.0	25	32.00

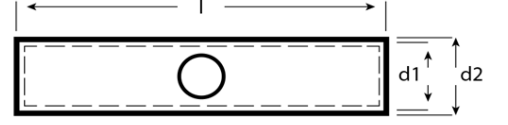

Malzeme : EN13600 Standart Bakır

Yüzey : Kalay

EK MUFLARI

Sipariş Kodu	Ürün Kodu	Kablo Kesit (mm ²)	Boyutlar			Kutu/Amb. Adet	Birim Fiyat TL / Adet
			d1	d2	l		
3465	EKMUF - 10	10	4.4	6.0	27.0	1.000	1.35
3466	EKMUF - 16	16	5.5	8.0	32.0	400	1.50
3467	EKMUF - 25	25	7.0	9.0	40.5	250	2.20
3468	EKMUF - 35	35	8.2	11.0	45.5	150	3.00
3469	EKMUF - 50	50	9.5	13.5	53.5	90	3.50
3470	EKMUF - 70	70	11.2	14.5	57.5	65	6.00
3471	EKMUF - 95	95	13.4	17.0	61.5	50	7.00
3472	EKMUF - 120	120	15.0	19.5	74.0	40	10.00
3473	EKMUF - 150	150	16.5	21.0	79.0	25	15.00
3474	EKMUF - 185	185	19.0	24.0	85.0	22	18.00
3475	EKMUF - 240	240	21.0	26.0	94.0	18	26.00



Sipariş Kodu	Ürün Kodu	Açıklama	Kutu Adet	Birim Fiyat TL / Adet
3480	U 6	6mm U Klemens	150	2.60
3481	U 10	10mm U Klemens	125	4.00
3482	U 16	16mm U Klemens	100	6.00
3483	U 25	25mm U Klemens	100	6.70
3484	U 35	35mm U Klemens	75	8.50
3485	U 50	50mm U Klemens	50	16.00
3486	U 70	70mm U Klemens	40	20.00
3487	U 95	95mm U Klemens	25	21.00
3488	U 120	120mm U Klemens	20	34.00
3489	U 150	150mm U Klemens	15	49.00



MONTAJ RAYLARI



35x7,5

Sipariş Kodu	Ürün Kodu	Açıklama	Uzunluk (m.)	Kutu Adet	Birim Fiyat TL / Adet
3495	GW - MR1	1mm Delikli Saç Montaj Rayı	1 m.	50	8.00
3496	GW - MR2	1mm Delikli Saç Montaj Rayı	2 m.	25	16.00

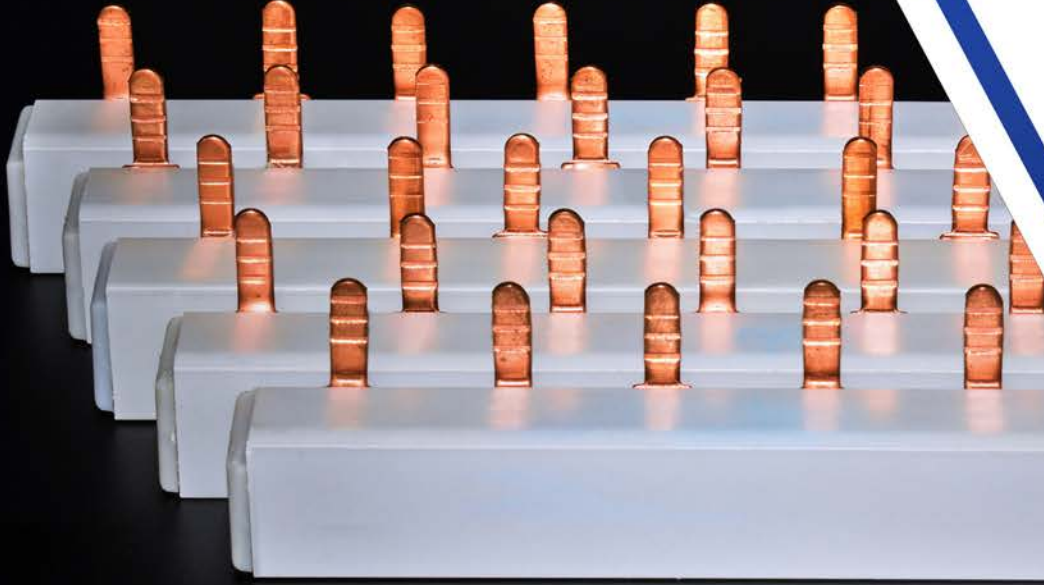
TRİFAZE BARALAR

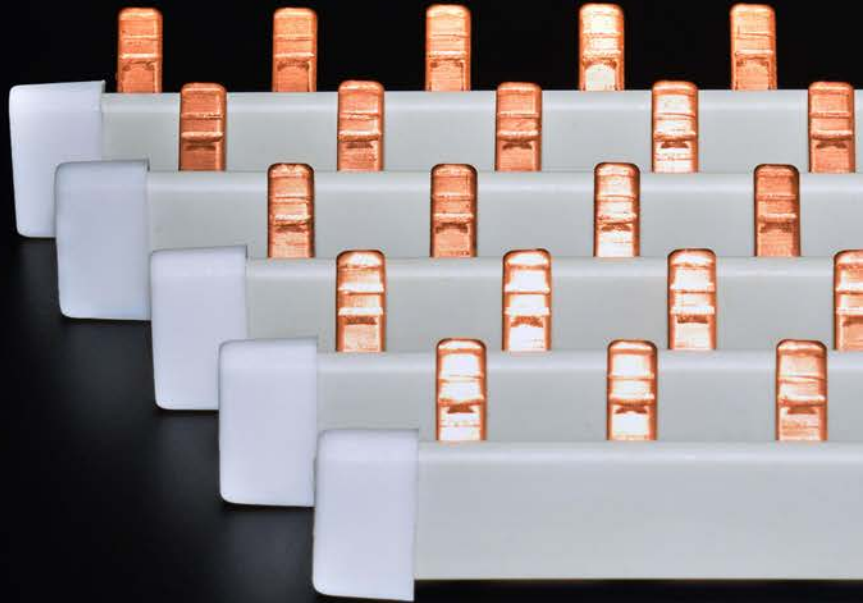

GWEST®



İMALATIMIZDIR.

MONOFAZE BARALAR

MONOFAZE MÜŞTEREK W OTOMAT BARALARI

Sipariş Kodu	Ürün Kodu	Bakır Kalınlığı	Boy	Modül	Amper	Açıklama	Kutu Adet	Fiyat TL / Adet
3601	M - 531	1 mm	53 cm	30 Otomat için	80 A	Monofaze Müşterek W Otomat Bara	50	17.00
3602	M - 1061	1 mm	106 cm	60 Otomat için	80 A	Monofaze Müşterek W Otomat Bara	50	34.00
3603	M - 5315	1.5 mm	53 cm	30 Otomat için	100 A	Monofaze Müşterek W Otomat Bara	50	25.00
3604	M - 10615	1.5 mm	106 cm	60 Otomat için	100 A	Monofaze Müşterek W Otomat Bara	50	50.00

TRİFAZE MÜŞTEREK W OTOMAT BARALARI

Sipariş Kodu	Ürün Kodu	Bakır Kalınlığı	Boy	Modül	Amper	Açıklama	Kutu Adet	Fiyat TL / Adet
3605	T - 221	1 mm	22 cm	4 Grup için	80 A	Trifaze Müşterek W Otomat Bara		18.00
3606	T - 331	1 mm	33 cm	6 Grup için	80 A	Trifaze Müşterek W Otomat Bara		27.00
3607	T - 441	1 mm	44 cm	8 Grup için	80 A	Trifaze Müşterek W Otomat Bara		36.00
3608	T - 531	1 mm	53 cm	10 Grup için	80 A	Trifaze Müşterek W Otomat Bara	25	45.00
3609	T - 1061	1 mm	106 cm	20 Grup için	80 A	Trifaze Müşterek W Otomat Bara	25	90.00

3610	T - 2215	1,5 mm	22 cm	4 Grup için	100 A	Trifaze Müşterek W Otomat Bara		28.00
3611	T - 3315	1,5 mm	33 cm	6 Grup için	100 A	Trifaze Müşterek W Otomat Bara		42.00
3612	T - 4415	1,5 mm	44 cm	8 Grup için	100 A	Trifaze Müşterek W Otomat Bara		56.00
3613	T - 5315	1,5 mm	53 cm	10 Grup için	100 A	Trifaze Müşterek W Otomat Bara	25	68.00
3614	T - 10615	1,5 mm	106 cm	20 Grup için	100 A	Trifaze Müşterek W Otomat Bara	25	136.00

3615	Gwest - KAP				Bara Kapağı	500	0.30
------	-------------	--	--	--	-------------	-----	------

İSTEDİĞİNİZ ÖLÇÜDE KESİM YAPILIR.

2 KUTUPLU DAĞITICI ÜNİTELER

Birim Fiyat TL / Adet	30.00	
SİPARİŞ KODU	3701	
ÜRÜN KODU	GW - 2x7	
AKIM	125 Amper	
KABLO CİNSİ	Tek Damar	Çok Telli
KABLO KESİTİ (mm²)	Giriş	Çıkış
	1x10-35 mm ²	1x10-25 mm ² 5x2,5-6 mm ²
	1x10-16 mm ²	1x6-16 mm ² 5x1,5-6 mm ²
Ambalaj Adet	Paket	Koli
	1	138

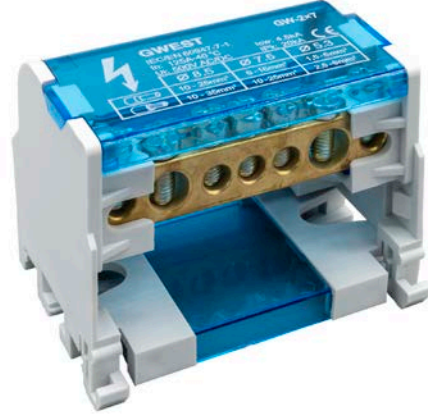

Birim Fiyat TL / Adet	42.00	
SİPARİŞ KODU	3702	
ÜRÜN KODU	GW - 2x11	
AKIM	125 Amper	
KABLO CİNSİ	Tek Damar	Çok Telli
KABLO KESİTİ (mm²)	Giriş	Çıkış
	2x10-35 mm ²	2x10-25 mm ² 7x2,5-6 mm ²
	2x10-16 mm ²	2x6-16 mm ² 7x1,5-6 mm ²
Ambalaj Adet	Paket	Koli
	1	84

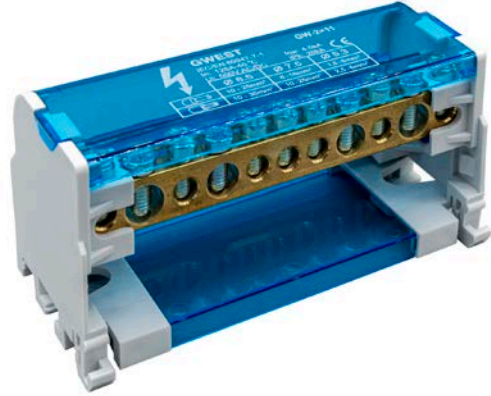

Birim Fiyat TL / Adet	54.00	
SİPARİŞ KODU	3703	
ÜRÜN KODU	GW - 2x15	
AKIM	125 Amper	
KABLO CİNSİ	Tek Damar	Çok Telli
KABLO KESİTİ (mm²)	Giriş	Çıkış
	2x10-35 mm ²	2x10-25 mm ² 11x2,5-6 mm ²
	2x10-16 mm ²	2x6-16 mm ² 11x1,5-6 mm ²
Ambalaj Adet	Paket	Koli
	1	72

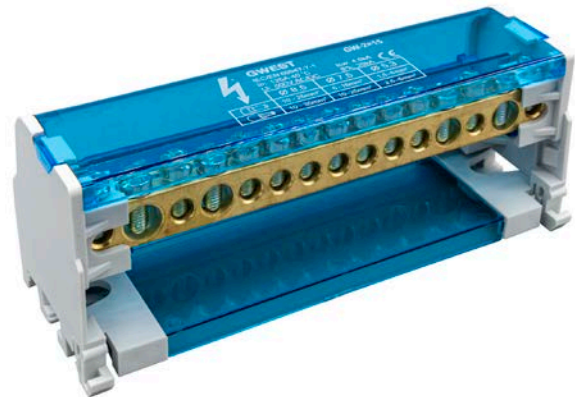

4 KUTUPLU DAĞITICI ÜNİTELER



Birim Fiyat TL / Adet	55.00	
SİPARİŞ KODU	3704	
ÜRÜN KODU	GW - 4x7	
AKIM	125 Amper	
KABLO CİNSİ	Tek Damar	Çok Telli
KABLO KESİTİ (mm²)	Giriş	Çıkış
	1x10-35 mm ²	1x10-25 mm ² 5x2,5-6 mm ²
	1x10-16 mm ²	1x6-16 mm ² 5x1,5-6 mm ²
Ambalaj Adet	Paket	Koli
	1	74

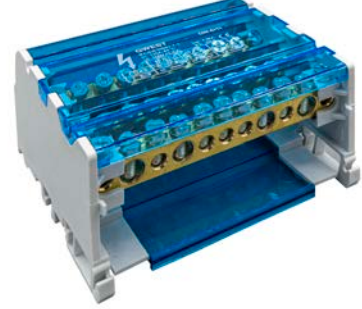

Birim Fiyat TL / Adet	78.00	
SİPARİŞ KODU	3705	
ÜRÜN KODU	GW - 4x11	
AKIM	125 Amper	
KABLO CİNSİ	Tek Damar	Çok Telli
KABLO KESİTİ (mm²)	Giriş	Çıkış
	2x10-35 mm ²	2x10-25 mm ² 7x2,5-6 mm ²
	2x10-16 mm ²	2x6-16 mm ² 7x1,5-6 mm ²
Ambalaj Adet	Paket	Koli
	1	50

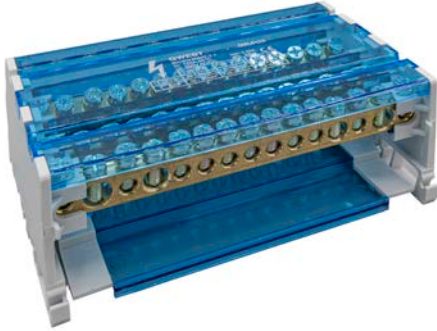

Birim Fiyat TL / Adet	100.00	
SİPARİŞ KODU	3706	
ÜRÜN KODU	GW - 4x15	
AKIM	125 Amper	
KABLO CİNSİ	Tek Damar	Çok Telli
KABLO KESİTİ (mm²)	Giriş	Çıkış
	2x10-35 mm ²	2x10-25 mm ² 11x2,5-6 mm ²
	2x10-16 mm ²	2x6-16 mm ² 11x1,5-6 mm ²
Ambalaj Adet	Paket	Koli
	1	40



Birim Fiyat TL / Adet	240.00	
SİPARİŞ KODU	3707	
ÜRÜN KODU	GW - 4x12/160A	
AKIM	160 Amper	
KABLO CİNSİ	Tek Damar	Çok Telli
KABLO KESİTİ (mm²)	Giriş	Çıkış
	1x10-50 mm ²	3x10-35 mm ² 8x2,5-16 mm ²
	1x10-50 mm ²	3x6-25 mm ² 8x1,5-16 mm ²
Ambalaj Adet	Paket	Koli
	1	18

TEK KUTUPLU DAĞITICI ÜNİTELER

Birim Fiyat TL / Adet	25.00	
SİPARİŞ KODU	3708	
ÜRÜN KODU	GW - 80A	
AKIM	80 Amper	
KABLO KESİTİ (mm ²)	Giriş	Çıkış
	1x10-16 mm ²	4x2,5-6 mm ² 2x2,5-16 mm ²
Ambalaj Adet	Paket	Koli
	5	100



Birim Fiyat TL / Adet	53.00	
SİPARİŞ KODU	3709	
ÜRÜN KODU	GW - 125A	
AKIM	125 Amper	
KABLO KESİTİ (mm ²)	Giriş	Çıkış
	1x10-35 mm ²	6x2,5-16 mm ² Köprü 1x6-16 mm ²
Ambalaj Adet	Paket	Koli
	5	75



Birim Fiyat TL / Adet	54.00	
SİPARİŞ KODU	3710	
ÜRÜN KODU	GW - 160A	
AKIM	160 Amper	
KABLO KESİTİ (mm ²)	Giriş	Çıkış
	1x10-70 mm ²	6x2,5-16 mm ² Köprü 1x6-16 mm ²
Ambalaj Adet	Paket	Koli
	5	50



TEK KUTUPLU DAĞITICI ÜNİTELER

Birim Fiyat TL / Adet	155.00	
SİPARİŞ KODU	3711	
ÜRÜN KODU	GW - 250A	
AKIM	250 Amper	
KABLO KESİTİ (mm ²)	Giriş	Çıkış
	1x35-120 mm ²	4x2,5-10 mm ² 5x2,5-16 mm ² 2x6-35 mm ²
Ambalaj Adet	Paket	Koli
	3	30



Birim Fiyat TL / Adet	160.00	
SİPARİŞ KODU	3712	
ÜRÜN KODU	GW - 400A	
AKIM	400 Amper	
KABLO KESİTİ (mm ²)	Giriş	Çıkış
	1x95-185 mm ²	4x2,5-10 mm ² 5x2,5-16 mm ² 2x6-35 mm ²
Ambalaj Adet	Paket	Koli
	3	20







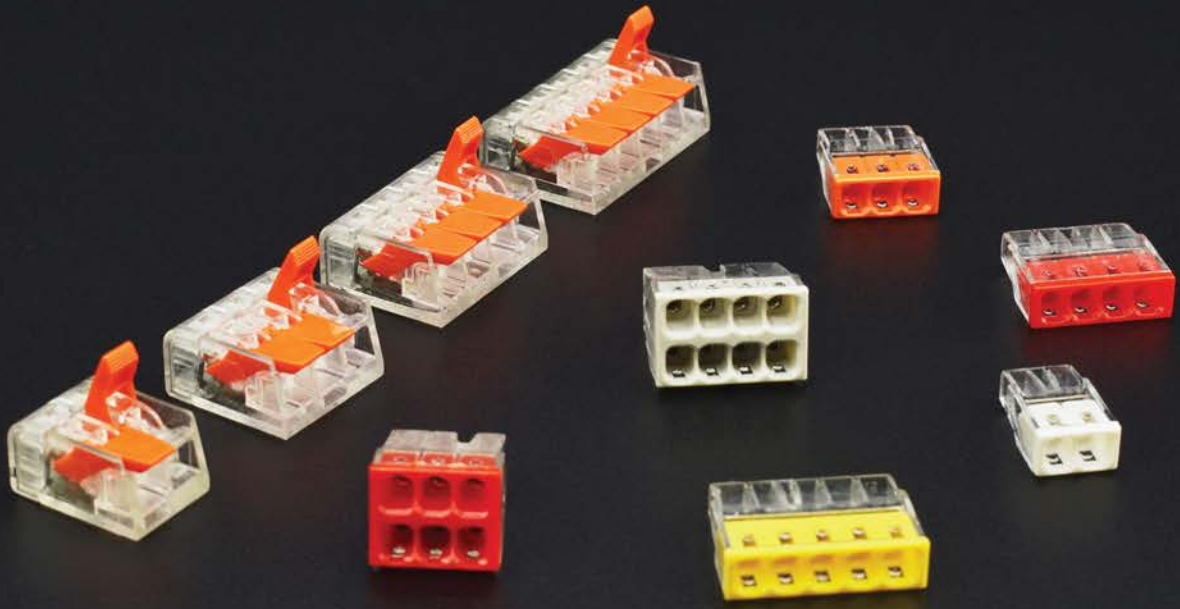

Birim Fiyat TL / Adet	170.00	
SİPARİŞ KODU	3713	
ÜRÜN KODU	GW - 500A	
AKIM	500 Amper	
KABLO KESİTİ (mm ²)	Giriş	Çıkış
	8x24 mm ²	4x2,5-10 mm ² 5x2,5-16 mm ² 2x6-35 mm ²
Ambalaj Adet	Paket	Koli
	3	20









KOMPAKT ÇOK AMAÇLI KLEMENSLER

GEÇMELİ BUAT KLEMENS

	Sipariş Kodu	Ürün Kodu	Renk	Kablo Kesiti	Ebatlar			Ambalaj Adet		Birim Fiyat TL / Adet
					En	Boy	Yükseklik	Paket	Koli	
	3501	GW 2,5 - 2	Beyaz	0,50 - 2,5 mm ²	9.8	16.4	5.8	200	10.000	0.680
	3502	GW 2,5 - 3	Turuncu	0,50 - 2,5 mm ²	13.9	16.4	5.8	200	10.000	0.770
	3503	GW 2,5 - 4	Kırmızı	0,50 - 2,5 mm ²	17.9	16.4	5.8	100	5.000	0.950
	3504	GW 2,5 - 5	Sarı	0,50 - 2,5 mm ²	21.9	16.4	5.8	100	5.000	1.000
	3505	GW 2,5 - 6	Kırmızı	0,50 - 2,5 mm ²	13.8	16.4	11.25	100	5.000	1.400
	3506	GW 2,5 - 8	Gri	0,50 - 2,5 mm ²	17.8	16.4	11.25	100	5.000	2.000

ÇOK AMAÇLI KLEMENS

	Sipariş Kodu	Ürün Kodu	Kablo Kesiti	Açıklama	Ambalaj Adet		Birim Fiyat TL / Adet
					Paket	Koli	
	3507	GW - 412	0,14 - 4,0 mm ²	2 İletken Bağlantılı	100	5.000	1.450
	3508	GW - 413	0,14 - 4,0 mm ²	3 İletken Bağlantılı	100	5.000	1.900
	3509	GW - 414	0,14 - 4,0 mm ²	4 İletken Bağlantılı	50	2.500	2.600
	3510	GW - 415	0,14 - 4,0 mm ²	5 İletken Bağlantılı	50	2.500	3.000

Çalışma Sıcaklığı: -40°C + 105°C

Nominal Akım : 32A

Nominal Gerilim : 450V



GÜVEN
ELEKTRİK ELEKTRONİK LTD. ŞTİ.

MAKARON GRUBU ve BANT ÇEŞİTLERİ



www.guvenelektrik.com.tr



ISI İLE DARALAN SİYAH MAKARONLAR

TEKNİK ÖZELLİKLER



Malzeme : Polyolefin

Daralma Oranı : 2/1

Yanmazlık : Kendi kendine söner

Çalışma Sıcaklığı : -55°C -- +125°C

Sipariş Kodu	Ölçü		Daralmadan Önce (mm)		Daralmadan Sonra (mm)		Makara / Mt.	Koli Miktarı	Birim Fiyat USD / Mt.
	Inch	mm	İç Çap	Cidar Kalınlığı	İç Çap	Cidar Kalınlığı			
4015	—	1	2,0 ± 0,3	0,16 ± 0,05	0,70	0,30 ± 0,05	200	3.200	0.065
4016	—	1,5	2,0 ± 0,3	0,16 ± 0,05	0,80	0,30 ± 0,05	200	2.400	0.068
4017	—	2	2,5 ± 0,3	0,16 ± 0,05	1,00	0,35 ± 0,05	200	3.000	0.074
4003	3/32	2,4	3,0 ± 0,3	0,16 ± 0,05	1,50	0,35 ± 0,05	200	3.000	0.074
4018	—	2,5	3,0 ± 0,3	0,16 ± 0,05	1,25	0,38 ± 0,05	200	2.600	0.095
4019	—	3	3,5 ± 0,4	0,20 ± 0,05	1,50	0,38 ± 0,05	200	2.200	0.102
4004	1/8	3,2	3,5 ± 0,4	0,20 ± 0,05	1,75	0,40 ± 0,05	200	2.200	0.102
4020	—	3,5	4,0 ± 0,4	0,20 ± 0,05	1,75	0,40 ± 0,05	200	1.800	0.11
4021	—	4	4,5 ± 0,4	0,20 ± 0,05	2,00	0,45 ± 0,05	200	1.400	0.13
4022	—	4,5	4,8 ± 0,4	0,20 ± 0,05	2,00	0,47 ± 0,08	100	1.000	0.15
4005	3/16	4,8	5,2 ± 0,4	0,20 ± 0,05	2,60	0,47 ± 0,08	100	1.000	0.15
4023	—	5	5,5 ± 0,4	0,20 ± 0,05	2,50	0,55 ± 0,08	100	900	0.16
4024	—	6	6,5 ± 0,4	0,22 ± 0,05	3,00	0,55 ± 0,08	100	700	0.18
4006	1/4	6,4	7,0 ± 0,4	0,28 ± 0,05	3,50	0,55 ± 0,08	100	700	0.18
4025	—	7	7,5 ± 0,4	0,28 ± 0,05	3,50	0,60 ± 0,08	100	500	0.23
4026	—	8	8,5 ± 0,4	0,30 ± 0,08	4,00	0,60 ± 0,08	100	1.300	0.23
4007	3/8	9,5	10,0 ± 0,5	0,30 ± 0,08	5,00	0,60 ± 0,08	100	1.200	0.24
4028	—	10	10,0 ± 0,5	0,30 ± 0,08	5,00	0,60 ± 0,08	100	1.100	0.26
4008	1/2	12,7	13,0 ± 0,5	0,33 ± 0,10	6,50	0,65 ± 0,08	100	1.000	0.29
4031	—	13	13,5 ± 0,5	0,33 ± 0,10	6,50	0,65 ± 0,08	100	900	0.31
4032	—	14	14,5 ± 0,5	0,33 ± 0,10	7,00	0,70 ± 0,08	100	900	0.38
4034	4/5	16	16,5 ± 0,6	0,35 ± 0,12	8,00	0,75 ± 0,08	100	800	0.50
4036	—	18	19,0 ± 0,6	0,40 ± 0,15	9,00	0,80 ± 0,15	100	700	0.67
4009	3/4	19,1	20,5 ± 0,6	0,40 ± 0,15	10,00	0,80 ± 0,15	100	700	0.67
4038	—	20	20,5 ± 0,6	0,40 ± 0,15	10,00	0,80 ± 0,15	100	600	0.81
4039	—	22	22,5 ± 0,7	0,45 ± 0,15	12,00	0,95 ± 0,15	100	600	0.97
4010	1	25,4	25,6 ± 0,7	0,45 ± 0,15	12,00	0,95 ± 0,15	50	300	1.10
4040	—	30	31,5 ± 0,7	0,50 ± 0,15	15,00	0,95 ± 0,15	50	250	1.40
4011	1 - 1/4	32	33,0 ± 0,7	0,50 ± 0,15	16,50	0,95 ± 0,15	50	250	1.40
4041	—	35	38,0 ± 0,7	0,50 ± 0,15	16,00	1,00 ± 0,15	50	200	1.95
4012	1 - 1/2	38	40,0 ± 0,7	0,50 ± 0,15	20,00	1,00 ± 0,15	50	200	2.10
4042	—	40	40,5 ± 0,7	0,50 ± 0,15	20,00	1,00 ± 0,15	50	200	2.10
4013	2	51	52,5 ± 0,7	0,50 ± 0,15	25,00	1,00 ± 0,15	25	125	3.00
4043	—	60	60,5 ± 0,8	0,52 ± 0,15	30,00	1,00 ± 0,16	25	100	4.10
4044	—	70	70,5 ± 1,0	0,55 ± 0,15	40,00	1,10 ± 0,18	25	75	5.30
4045	—	80	82,0 ± 1,0	0,55 ± 0,15	40,00	1,10 ± 0,18	25	75	6.10
4050	—	90	90,0 ± 1,0	0,55 ± 0,15	45,00	1,10 ± 0,18	25	50	6.40
4046	4	102	105,0 ± 1,0	0,55 ± 0,15	51,00	1,10 ± 0,18	25	50	7.50
4047	—	120	120,0 ± 1,0	0,55 ± 0,15	60,00	1,10 ± 0,18	25	50	11.00
4048	—	150	150,0 ± 1,0	0,55 ± 0,15	76,00	1,10 ± 0,18	25	50	17.00
4049	—	180	180,0 ± 1,0	0,55 ± 0,15	90,00	1,10 ± 0,18	25	25	23.00

ISI İLE DARALAN RENKLİ MAKARONLAR

ŞEFFAF - BEYAZ - KIRMIZI - MAVİ - SARI - YEŞİL - GRİ

Ölçü		Sipariş Kodu							Makara / Mt.	Koli Miktarı	Fiyat Usd / Mt.
Inch	mm	ŞEFFAF	BEYAZ	KIRMIZI	MAVİ	SARI	YEŞİL	GRİ			
—	1,5	4201	4289	4219	4237	4254	4272	4306	200	3.200	0.09
—	2,5	4202	4290	4220	4238	4256	4273	4307	200	2.600	0.13
1/8	3,2	4203	4291	4221	4239	4257	4274	4308	200	2.200	0.15
—	3,5	—	4292	—	—	4258	—	—	200	1.800	0.16
Yassı	3,5	—	4395	—	—	4390	—	—	100	1.600	0.16
3/16	4,8	4204	4293	4222	4240	4259	4275	4309	100	1.000	0.18
Yassı	4,8	—	4396	—	—	4391	—	—	100	1.500	0.18
1/4	6,4	4205	4294	4224	4241	4260	4276	4310	100	700	0.23
Yassı	6,4	—	4397	—	—	4392	—	—	100	1.500	0.23
Yassı	7	—	4398	—	—	4393	—	—	100	1.400	0.24
3/8	9,5	4207	4295	4226	4242	4261	4278	4311	100	1.200	0.28
—	13	4208	4296	4227	4243	4262	4279	4312	100	900	0.38
4/5	16	4209	4297	4228	4244	4263	4280	4313	100	800	0.67
—	20	4210	4298	4229	4245	4264	4281	4314	100	600	1.20
1	25,4	4211	4299	4230	4246	4265	4282	4315	50	300	1.45
1 - 1/4	32	4212	4300	4231	4247	4266	4283	4316	50	250	1.95
1 - 1/2	38	4213	4301	4232	4248	4267	4284	4317	50	200	3.00
2	51	4214	4302	4233	4249	4268	4285	4318	25	125	3.40
—	60	4215	4303	4234	4250	4269	4286	4319	25	100	5.30
—	80	4216	4304	4235	4251	4270	4287	4320	25	75	6.60
4	102	4217	4305	4236	4252	4271	4288	4321	25	50	8.85



TEKNİK ÖZELLİKLER

- **Malzeme** : Polyolefin
- **Daralma Oranı** : 2/1
- **Yanmazlık** : Kendi kendine söner
- **Çalışma Sıcaklığı** : -55°C -- +125°C



ISI İLE DARALAN RENKLİ MAKARONLAR

KAHVERENGİ - TURUNCU - MOR

Ölçü		Sipariş Kodu			Makara / Mt.	Koli Miktarı	Fiyat Usd / Mt.
Inch	mm	KAHVERENGİ	TURUNCU	MOR			
—	1,5	4322	4338	4354	200	3.200	0.09
—	2,5	4323	4339	4355	200	2.600	0.14
1/8	3,2	4324	4340	4356	200	2.200	0.17
3/16	4,8	4325	4341	4357	100	1.000	0.23
1/4	6,4	4326	4342	4358	100	700	0.30
3/8	9,5	4327	4343	4359	100	1.200	0.35
—	13	4328	4344	4360	100	900	0.46
4/5	16	4329	4345	4361	100	800	0.92
—	20	4330	4346	4362	100	600	1.20
1	25,4	4331	4347	4363	50	300	1.60
1 - 1/4	32	4332	4348	4364	50	250	2.15
1 - 1/2	38	4333	4349	4365	50	200	3.50
2	51	4334	4350	4366	25	125	3.90
—	60	4335	4351	4367	25	100	6.00
—	80	4336	4352	4368	25	75	8.10
4	102	4337	4353	4369	25	50	11.00



TEKNİK ÖZELLİKLER

- **Malzeme :** Polyolefin
- **Daralma Oranı :** 2/1
- **Yanmazlık :** Kendi kendine söner
- **Çalışma Sıcaklığı :** -55°C -- +125°C



ISI İLE DARALAN MAKARONLAR

SARI YEŞİL

Sipariş Kodu	Ölçü		Daralmadan Önce (mm)		Daralmadan Sonra (mm)		Makara / Mt.	Koli Miktarı	Birim Fiyat USD / Mt.
	Inch	mm	İç Çap	Cidar Kalınlığı	İç Çap	Cidar Kalınlığı			
4102	3/32	2,4	3,0 ± 0,3	0,16 ± 0,05	1,50	0,35 ± 0,05	200	3.000	0.32
4103	1/8	3,2	3,5 ± 0,4	0,20 ± 0,05	1,75	0,40 ± 0,05	200	2.200	0.33
4104	3/16	4,8	5,2 ± 0,4	0,20 ± 0,05	2,60	0,47 ± 0,08	100	1.000	0.34
4105	1/4	6,4	7,0 ± 0,4	0,28 ± 0,05	3,50	0,55 ± 0,08	100	700	0.41
4106	3/8	9,5	10,0 ± 0,5	0,30 ± 0,08	5,00	0,60 ± 0,08	100	1.200	0.56
4107	—	13	13,5 ± 0,5	0,33 ± 0,10	6,50	0,65 ± 0,08	100	900	0.75
4108	4/5	16	16,5 ± 0,6	0,35 ± 0,12	8,00	0,75 ± 0,08	100	800	1.10
4109	—	20	20,5 ± 0,6	0,40 ± 0,15	10,00	0,80 ± 0,15	100	600	1.40
4110	1	25,4	25,6 ± 0,7	0,45 ± 0,15	12,00	0,95 ± 0,15	50	300	2.10
4111	1 - 1/4	32	33,0 ± 0,7	0,50 ± 0,15	16,50	0,95 ± 0,15	50	250	2.70
4112	1 - 1/2	38	40,0 ± 0,7	0,50 ± 0,15	20,00	1,00 ± 0,15	50	200	3.80
4113	2	51	52,5 ± 0,7	0,50 ± 0,15	25,00	1,00 ± 0,15	50	125	5.50
4114	—	60	60,5 ± 0,8	0,52 ± 0,15	30,00	1,00 ± 0,16	25	100	7.50
4115	—	80	82,0 ± 1,0	0,55 ± 0,15	40,00	1,10 ± 0,18	25	75	12.00
4116	4	102	105,0 ± 1,0	0,55 ± 0,15	51,00	1,10 ± 0,18	25	50	18.00



TEKNİK ÖZELLİKLER

- **Malzeme** : Polyolefin
- **Daralma Oranı** : 2/1
- **Yanmazlık** : Kendi kendine söner
- **Çalışma Sıcaklığı** : -55°C -- +125°C



İÇİ YAPIŞKANLI DARALAN MAKARONLAR

Sipariş Kodu	Ölçü mm	Daralmadan Önce (mm)	Daralmadan Sonra (mm)			Makara / Mt.	Koli Miktarı	Birim Fiyat USD / Mt.
		İç Çap	Azami İç Çap	Anma Cidar Kalınlığı	Anma Yapışkanlığı			
4418	3/1	3	1.00	1.10 ± 0.10	0.50	200	1.800	0.65
4419	4.8/1.5	4.8	1.50	1.20 ± 0.10	0.50	100	900	0.80
4420	6/2	6	2.00	1.30 ± 0.10	0.50	100	600	1.10
4421	9/3	9	3.00	1.70 ± 0.15	0.60	50	300	1.40
4405	12/4	12	4.00	2.00 ± 0.20	0.80	1.20 Boy	250	2.30
4406	16/5	16	5.00	2.20 ± 0.20	0.80	1.20 Boy	250	2.70
4407	19/6	19	6.00	2.30 ± 0.20	0.80	1.20 Boy	150	3.70
4408	28/9	28	9.00	2.40 ± 0.20	1.05	1.20 Boy	110	4.20
4409	33/10	33	10.00	2.50 ± 0.20	1.05	1.20 Boy	100	5.00
4410	40/12	40	12.00	2.50 ± 0.20	1.05	1.20 Boy	90	5.60
4411	44/14	44	14.00	2.50 ± 0.20	1.05	1.20 Boy	60	6.50
4412	52/18	52	18.00	2.50 ± 0.20	1.05	1.20 Boy	60	7.30
4414	70/25	70	25.00	3.00 ± 0.30	1.35	1.20 Boy	32	9.70
4415	90/30	90	30.00	3.00 ± 0.30	1.35	1.20 Boy	24	14.00
4416	125/40	125	40.00	3.00 ± 0.30	1.35	1.20 Boy	20	18.00



TEKNİK ÖZELLİKLER

- **Malzeme** : Polyolefin
- **Daralma Oranı** : 3/1
- **Yanmazlık** : Kendi kendine söner
- **Çalışma Sıcaklığı** : -45°C -- +125°C



WWOER®
www.woer.com.tr

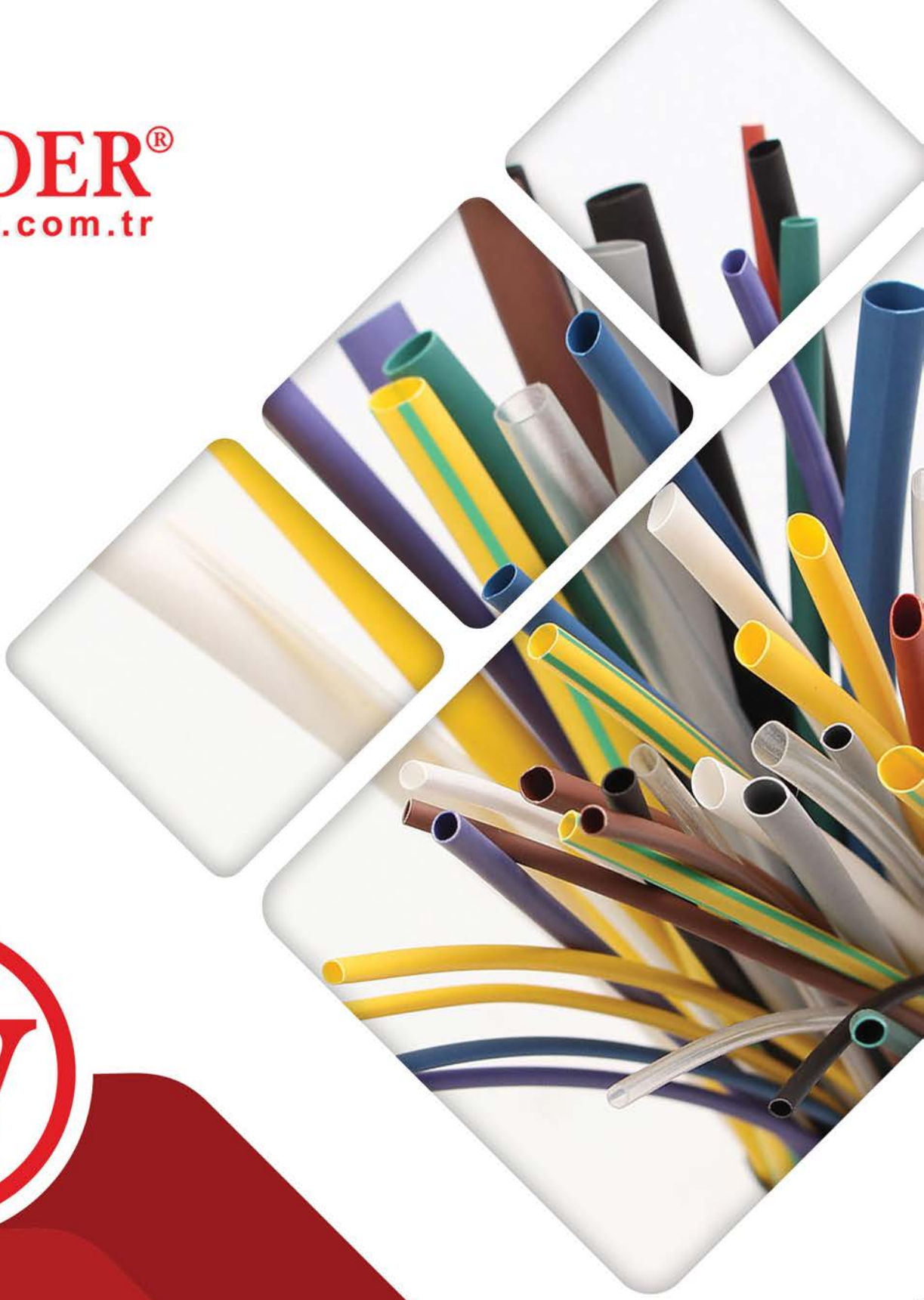

- ISI İLE DARALAN MAKARONLAR
- İÇİ YAPIŞKANLI DARALAN MAKARONLAR



KABLO TOPLAMA ÇORABI

Sipariş Kodu	Ölçü	Renk	Esneleme Aralığı		Makara / Mt.	Birim Fiyat USD / Mt.
			Min (mm)	Max (mm)		
4501	3 mm	Siyah	1	6	100	0.17
4502	6 mm	Siyah	3	9	100	0.21
4503	8 mm	Siyah	5	16	100	0.24
4504	10 mm	Siyah	7	19	100	0.28
4505	12 mm	Siyah	8	24	100	0.33
4506	15 mm	Siyah	10	27	100	0.38
4507	20 mm	Siyah	14	30	100	0.45
4508	25 mm	Siyah	18	35	100	0.58
4509	30 mm	Siyah	20	50	50	0.68
4510	40 mm	Siyah	30	60	50	0.90
4511	50 mm	Siyah	40	80	25	1.10

TEKNİK ÖZELLİKLER

- **Malzeme :** Pet (Polyester)
- **Çalışma Sıcaklığı :** -50°C -- +150°C
- **Dayanım Üst Noktası :** 220 °C
- **Erime Noktası :** +250 °C

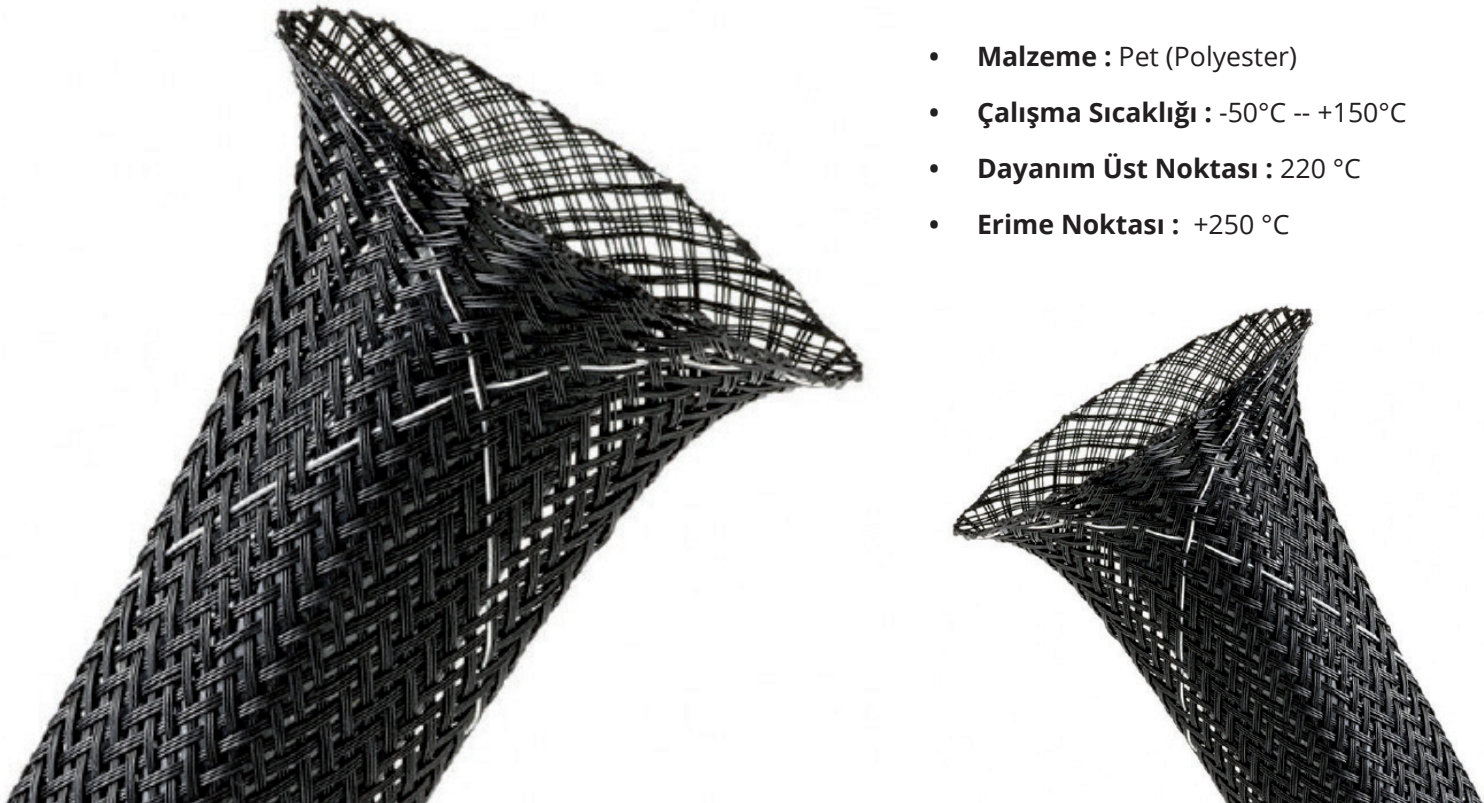

H CLASS CAM ELYAF SİLİKON İZOLELİ MAKARONLAR

Sipariş Kodu	Ölçü	Renk	Makara / Mt.	Koli Miktarı	Birim Fiyat USD / Mt.
4703	2 mm	Kırmızı	200	2.600	0.20
4705	3 mm	Kırmızı	100	2.000	0.26
4706	4 mm	Kırmızı	100	1.500	0.36
4707	5 mm	Kırmızı	100	1.000	0.45
4708	6 mm	Kırmızı	100	1.000	0.52
4709	7 mm	Kırmızı	100	1.000	0.68
4710	8 mm	Kırmızı	50	1.000	0.75
4711	10 mm	Kırmızı	50	600	1.15
4712	12 mm	Kırmızı	50	500	1.25
4713	14 mm	Kırmızı	50	500	1.70
4714	16 mm	Kırmızı	25	500	2.10
4715	18 mm	Kırmızı	25	400	2.50
4716	20 mm	Kırmızı	25	400	3.20
4717	25 mm	Kırmızı	25	350	6.00
4718	30 mm	Kırmızı	25	150	8.80
4719	35 mm	Kırmızı	25	150	11.00



TEKNİK ÖZELLİKLER

- **Malzeme :** Silikon İzoleli Cam Elyaf Örgü Makaron
- **Çalışma Sıcaklığı :** -60 °C -- +250 °C

PVC İZOLELİ CAM ELYAF MAKARONLAR

Sipariş Kodu	Ölçü	Renk	Makara / Mt.	Koli Miktarı	Birim Fiyat USD / Mt.
4604	2 mm	Beyaz Üzeri Çizgili	200	2.400	0.12
4606	3 mm	Beyaz Üzeri Çizgili	100	2.400	0.15
4608	4 mm	Beyaz Üzeri Çizgili	100	2.000	0.19
4609	5 mm	Beyaz Üzeri Çizgili	100	1.400	0.26
4610	6 mm	Beyaz Üzeri Çizgili	100	1.300	0.32
4611	7 mm	Beyaz Üzeri Çizgili	100	1.200	0.36
4612	8 mm	Beyaz Üzeri Çizgili	100	1.000	0.40
4613	10 mm	Beyaz Üzeri Çizgili	50	1.000	0.54
4614	12 mm	Beyaz Üzeri Çizgili	50	1.000	0.68
4615	14 mm	Beyaz Üzeri Çizgili	50	650	0.80
4616	16 mm	Beyaz Üzeri Çizgili	50	600	1.15
4617	18 mm	Beyaz Üzeri Çizgili	50	400	1.30
4618	20 mm	Beyaz Üzeri Çizgili	25	400	1.60



TEKNİK ÖZELLİKLER





- **Malzeme :** PVC İzoleli Cam Elyaf Makaron
- **Çalışma Sıcaklığı :** -20 °C -- +130 °C



ERİYEN BANTLAR

SİPARİŞ KODU	ÜRÜN KODU	ÖLÇÜLER	KOLİ ADET	Birim Fiyat USD / Ad.
4801	GWEST - 1401	19 mm x 0.8 mm x 8 m	60	2.10
4802	GWEST - 1402	50 mm x 0.8 mm x 8 m	24	5.50



İZOLE BANTLAR

	SİPARİŞ KODU	ÜRÜN KODU	ÖLÇÜLER	KOLİ ADET	Birim Fiyat TL / Ad.
	4803	GLOBE	0.13 mm x 19 mm x 9.1 m	500	
	4804	GLOBE	0.50 mm x 50 mm x 9.1 m	60	
	4805	SARI YEŞİL GLOBE	0.13 mm x 19 mm x 9.1 m	500	

	SİPARİŞ KODU	ÜRÜN KODU	ÖLÇÜLER	KOLİ ADET	Birim Fiyat TL / Ad.
	4809	İZOLE BANT	0.13 mm x 19 mm x 9.1 m	500	
	4810	İZOLE BANT	0.50 mm x 50 mm x 9.1 m	36	

SICAK HAVA TABANCASI

	SİPARİŞ KODU	ÜRÜN KODU	GÜÇ	SICAKLIK	KOLİ ADET	Birim Fiyat USD / Ad.
	4903	GW 2000	2000 W	150 / 300 / 500 °C	10	60.00



GÜVEN
ELEKTRİK ELEKTRONİK LTD. ŞTİ.

**MEKANİK
ve
HİDROLİK
EL ALETLERİ**



www.guvenelektrik.com.tr



YÜKSÜK SIKMA PENSELERİ / MEKANİK EL ALETLERİ

Sipariş Kodu: 5026	Ürün Kodu: YYT B-4
0.25 - 6 mm ² Yüksek Sıkma Pensesi	
	
62.00 USD	

Sipariş Kodu: 5005	Ürün Kodu: YAC - 5
0.50 - 6 mm ² Yüksek Sıkma Pensesi	
	
64.00 USD	

Sipariş Kodu: 5006	Ürün Kodu: YAC - 6
6 - 16 mm ² Yüksek Sıkma Pensesi	
	
64.00 USD	

Sipariş Kodu: 5008	Ürün Kodu: YAC - 8
0.08 - 6 mm ² Yüksek Sıkma Pensesi (4 Köşe)	
	
80.00 USD	

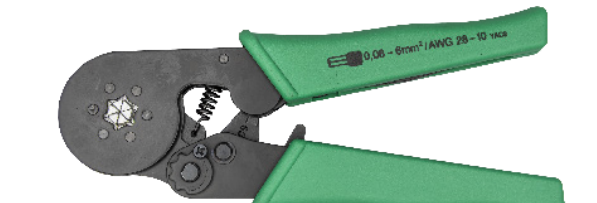
Sipariş Kodu: 5009	Ürün Kodu: YAC - 9
0.08 - 6 mm ² Yüksek Sıkma Pensesi (6 Köşe)	
	
105.00 USD	

Sipariş Kodu: 5015	Ürün Kodu: YAC - 17
25 - 35 mm ² Yüksek Sıkma Pensesi	
	
71.00 USD	

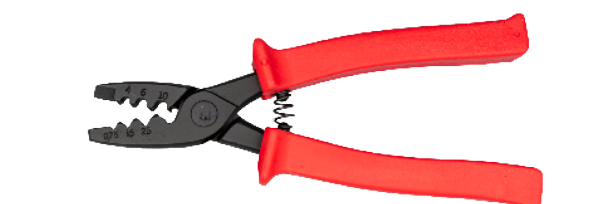
Sipariş Kodu: 5024	Ürün Kodu: YYT - 21
0.75 - 10 mm ² Yüksek Sıkma Pensesi	
	
36.00 USD	

Sipariş Kodu: 5025	Ürün Kodu: YYT - 22
0.50 - 2.5 mm ² Yüksek Sıkma Pensesi	
	
35.00 USD	

İZOLESİZ KABLO UCU VE KONNEKTÖR SIKMA PENSELERİ MEKANİK EL ALETLERİ

Sipariş Kodu: 5021	Ürün Kodu: YYT - 11
0.50 - 6 mm ² İzolesiz Terminal Sıkma Pensesi	
	
65.00 USD	

Sipariş Kodu: 5022	Ürün Kodu: YYT - 12
1.00 - 10 mm ² İzolesiz Terminal Sıkma Pensesi	
	
65.00 USD	

Sipariş Kodu: 5014	Ürün Kodu: YAC - 16
Eğri Terminal Sıkma Pensesi	
	
71.00 USD	

Sipariş Kodu: 5012	Ürün Kodu: YAC - 12
28 - 22 / 22 - 18 (JST) Konnektör Ucu Sıkma Pensesi (AWG)	
	
68.00 USD	

Sipariş Kodu: 5013	Ürün Kodu: YAC - 13
28 - 22 / 24 - 18 (Molex) Konnektör Ucu Sıkma Pensesi (AWG)	
	
68.00 USD	

Sipariş Kodu: 5059	Ürün Kodu: HD - 11010
AWG 24 - 14 Konnektör Sıkma Pensesi	
	
60.00 USD	



Sipariş Kodu: 5060	Ürün Kodu: HD - 11011
AWG 30 - 18 Konnektör Sıkma Pensesi	
	
60.00 USD	



İZOLELİ KABLO UCU VE KONNEKTÖR SIKMA PENSELERİ MEKANİK EL ALETLERİ



Sipariş Kodu: 5016	Ürün Kodu: YYT - 1
0.50 - 6 mm ² İzoleli Kablo Ucu Sıkma Pensesi	
	
	
56.00 USD	

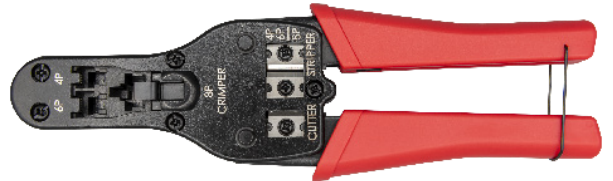

Sipariş Kodu: 5017	Ürün Kodu: YYT - 7
0.50 - 6 mm ² İzoleli Kablo Ucu Sıkma Pensesi	
	
	
65.00 USD	

KONNEKTÖR SIKMA PENSELERİ MEKANİK EL ALETLERİ

Sipariş Kodu: 5065	Ürün Kodu: RJ - 86
6 p / 8 p Konnektör Sıkma Pensesi	
	
	
56.00 USD	

Sipariş Kodu: 5066	Ürün Kodu: ASA - 486
4 p / 6 p / 8 p Konnektör Sıkma Pensesi	
	
	
90.00 USD	

Sipariş Kodu: 5002	Ürün Kodu: YAC - 3
0.068 - 0.324 BNC Konnektör Sıkma Pensesi (AWG)	
	
	
63.00 USD	

Sipariş Kodu: 5063	Ürün Kodu: RG - 9600
AWG 24 -14 Konnektör Sıkma Pensesi	
	
	
60.00 USD	

MULTİ FONKSİYONEL YÜKSÜK VE KABLO UCU SIKMA PENSESİ

Sipariş Kodu: 5070	Ürün Kodu: T03C - 5D
Takım İçerikli Çanta	
Takım İçeriği YAC 5 Yüksük Sıkma 0.5 - 6 mm YAC 6 Yüksük Sıkma 6 - 16 mm YYT 1 Kablo Ucu Sıkma 0.5 - 6 mm YYT 11 İzolesiz Terminal Sıkma 1 - 4mm YYT 8 Kaynaklı Papuç Sıkma 0.5 - 10mm	
	
145.00 USD	

KABLO SIYIRICILARI / MEKANİK EL ALETLERİ

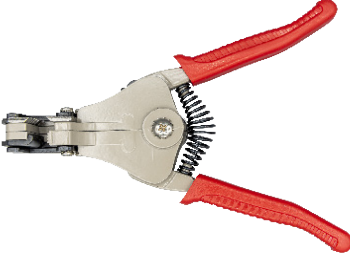
Sipariş Kodu: 5037	Ürün Kodu: TP - 700A
0.50 - 2 mm ² Tekli Kablo Siyırma Pensesi	
	
37.00 USD	

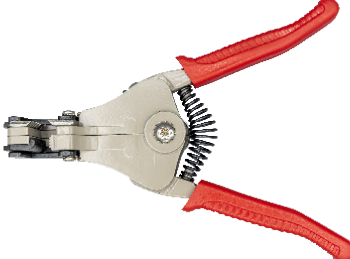
Sipariş Kodu: 5036	Ürün Kodu: TP - 700B
1 - 3.2 mm ² Tekli Kablo Siyırma Pensesi	
	
37.00 USD	

Sipariş Kodu: 5028	Ürün Kodu: YY - 78 - 318
0.50 - 6 mm ² İzoleli Kablo Ucu Sıkma Pensesi	
	
29.00 USD	

KABLO BAĞI SIKMA PENSELERİ

Sipariş Kodu: 5054	Ürün Kodu: TG - 008
2.2 - 4.8 mm ² Kablo Bağı Sıkma Pensesi	
	
55.00 USD	

Sipariş Kodu: 5055	Ürün Kodu: TG - 009
3.6 - 9 mm ² Kablo Bağı Sıkma Pensesi	
	
37.00 USD	

Sipariş Kodu: 5056	Ürün Kodu: TG - 011
4.6 - 12 mm ² Metal Kablo Bağı Sıkma Pensesi	
	
160.00 USD	

KABLO PAPUCU SIKMA PENSELERİ

Sipariş Kodu: 5018	Ürün Kodu: YYT - 8
1.5 - 10 mm ² SKP Sıkma Pensesi	
	
57.00 USD	

Sipariş Kodu: 5019	Ürün Kodu: YYT - 9
10 - 16 mm ² SKP Sıkma Pensesi	
	
57.00 USD	

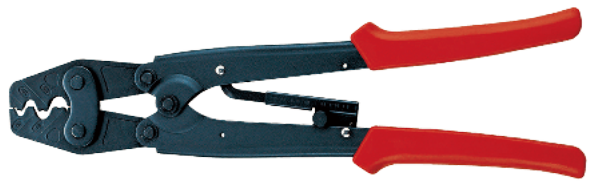
Sipariş Kodu: 5057	Ürün Kodu: HD - 25L
6 - 25 mm ² SKP Sıkma Pensesi	
	
87.00 USD	

Sipariş Kodu: 5045	Ürün Kodu: JY - 0650
6 - 50 mm ² SKP Sıkma Pensesi	
	
71.00 USD	

Sipariş Kodu: 5046	Ürün Kodu: JY - 06120
10 - 120 mm ² SKP Sıkma Pensesi	
	
140.00 USD	

Sipariş Kodu: 5047	Ürün Kodu: JY - 25150
25 - 150 mm ² SKP Sıkma Pensesi	
	
142.00 USD	

HİDROLİK SIKMA VE KESME PENSELERİ

Sipariş Kodu: 5050	Ürün Kodu: YYQ 120
10 - 120 mm ² Hidrolik SKP Sıkma Pensesi (Çantalı Set)	
	
140.00 USD	

Sipariş Kodu: 5051	Ürün Kodu: YQK 300
16 - 300 mm ² Hidrolik SKP Sıkma Pensesi (Çantalı Set)	
	
150.00 USD	

Sipariş Kodu: 5052	Ürün Kodu: CPC - 40A
Kesme Kuvveti 6 Ton, Kesme Kapasitesi 32mm ² Cu/Alu	
	
340.00 USD	

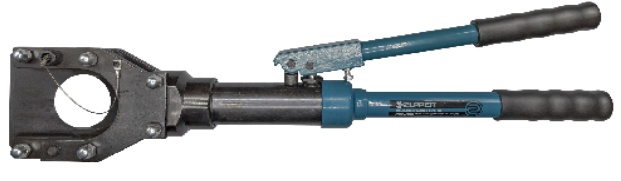
Sipariş Kodu: 5053	Ürün Kodu: CPC - 50A
Kesme Kuvveti 6 Ton, Kesme Kapasitesi 45mm ² Cu/Alu	
	
400.00 USD	

KABLO KESME MAKASLARI

Sipariş Kodu: 5040

Ürün Kodu: CC- 60

60 mm² Kablo Kesme Makası

33.00 USD

Sipariş Kodu: 5041

Ürün Kodu: TC- 100

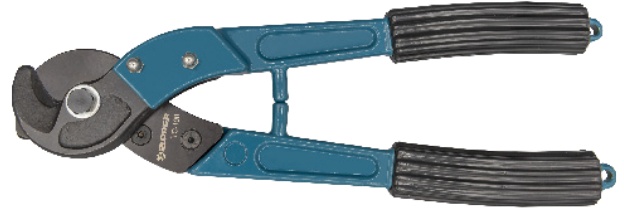
120 mm² Kablo Kesme Makası

58.00 USD

Sipariş Kodu: 5042

Ürün Kodu: TC- 250

250 mm² Kablo Kesme Makası

107.00 USD

Sipariş Kodu: 5044

Ürün Kodu: TC - 500

630 mm² Kablo Kesme Makası

165.00 USD

Sipariş Kodu: 5067

Ürün Kodu: TCR- 325

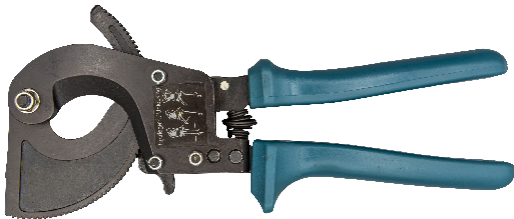
325 mm² Bakır ve Alüminyum Kablo Kesme Makası

165.00 USD

Sipariş Kodu: 5068

Ürün Kodu: ZC - 60A

500 mm² Bakır ve Alüminyum Kablo Kesme Makası

230.00 USD

Sipariş Kodu: 5069

Ürün Kodu: ZCR - 52

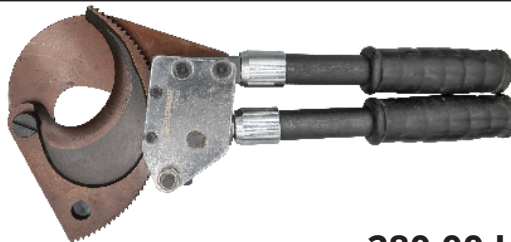
500 mm² Çok Telli Kablo Kesme Makası

280.00 USD



GÜVEN
ELEKTRİK ELEKTRONİK LTD. ŞTİ.

BUTON SERİSİ ve AKSESUARLARI









www.guvenelektrik.com.tr





Q 22mm BUTON SERİSİ



















YAYLI BUTONLAR

	SİPARİŞ KODU	ÜRÜN KODU	KONTAK	AÇIKLAMA	RENK	KUTU ADET	KOLI ADET	Birim Fiyat TL / Ad.
	6001	A5 - 10	1NO	Yaylı Buton	 Yeşil	10	300	13.00
	6002	A5 - 01	1NC	Yaylı Buton	 Kırmızı	10	300	13.00
	6003	A5 - 11	1NO	Yaylı Buton	 Sarı	10	300	13.00
	6004	A5 - 21	1NO	Yaylı Buton	 Mavi	10	300	13.00
	6005	A5 - 31	1NO	Yaylı Buton	 Beyaz	10	300	13.00
	6006	A5 - 41	1NO	Yaylı Buton	 Siyah	10	300	13.00

İŞARETLİ YAYLI BUTONLAR

	6007	A5 - 10/1	1NO	İşaretlili Yaylı Buton		10	300	15.00
	6008	A5 - 01/2	1NC	İşaretlili Yaylı Buton		10	300	15.00
	6009	A5 - 10/3	1NO	İşaretlili Yaylı Buton		10	300	15.00
	6010	A5 - 10/4	1NO	İşaretlili Yaylı Buton		10	300	15.00

İŞIKLI YAYLI BUTONLAR



	6011	A5 - 10D	1NO	Işıklı Yaylı Buton 220V AC/DC	 Yeşil	10	300	26.00
	6012	A5 - 01D	1NC		 Kırmızı	10	300	26.00
	6013	A5 - 11D	1NO		 Sarı	10	300	26.00
	6014	A5 - 21D	1NO		 Mavi	10	300	26.00
	6015	A5 - 31D	1NO		 Beyaz	10	300	26.00
	6016	A5 - 10D-110	1NO	Işıklı Yaylı Buton 110V AC/DC	 Yeşil	10	300	26.00
	6017	A5 - 01D-110	1NC		 Kırmızı	10	300	26.00
	6018	A5 - 11D-110	1NO		 Sarı	10	300	26.00
	6019	A5 - 21D-110	1NO		 Mavi	10	300	26.00
	6020	A5 - 31D-110	1NO		 Beyaz	10	300	26.00
	6021	A5 - 10D-24	1NO	Işıklı Yaylı Buton 24V AC/DC	 Yeşil	10	300	26.00
	6022	A5 - 01D-24	1NC		 Kırmızı	10	300	26.00
	6023	A5 - 11D-24	1NO		 Sarı	10	300	26.00
	6024	A5 - 21D-24	1NO		 Mavi	10	300	26.00
	6025	A5 - 31D-24	1NO		 Beyaz	10	300	26.00

Q 22mm BUTON SERİSİ

KALICI MANDAL BUTONLAR

	SİPARİŞ KODU	ÜRÜN KODU	KONTAK	AÇIKLAMA	KUTU ADET	KOLİ ADET	Birim Fiyat TL / Ad.
	6027	A5 - 10X	1NO	0 -1 Mandal Buton 	10	300	14.50
	6028	A5 - 20XS	2NO	1-0-2 Mandal Buton 	10	300	20.00



KAYICI MANDAL BUTONLAR

	SİPARİŞ KODU	ÜRÜN KODU	KONTAK	AÇIKLAMA	KUTU ADET	KOLİ ADET	Birim Fiyat TL / Ad.
	6029	A5 - 10X/FU	1NO	0 -1 Mandal Buton 	10	300	17.00
	6030	A5 - 20XS/FU	2NO	1-0-2 Mandal Buton 	10	300	24.00

KALICI - KAYICI MANDAL BUTON

	SİPARİŞ KODU	ÜRÜN KODU	KONTAK	AÇIKLAMA	KUTU ADET	KOLİ ADET	Birim Fiyat TL / Ad.
	6026	A5 - 20XS/F	2NO	1-0-2 Mandal Buton Sağ Pozisyon Kalıcı Sol Pozisyon Kayıcı 	10	300	23.00

ANAHTARLI KALICI BUTONLAR

	SİPARİŞ KODU	ÜRÜN KODU	KONTAK	AÇIKLAMA	KUTU ADET	KOLİ ADET	Birim Fiyat TL / Ad.
	6049	A5 - 10Y	1NO	0 -1 Anahtarlı Buton 	10	300	26.00
	6050	A5 - 20YS	2NO	1-0-2 Anahtarlı Buton 	10	300	32.00

Q 22mm BUTON SERİSİ

	SİPARİŞ KODU	ÜRÜN KODU	KONTAK	AÇIKLAMA	RENK	KUTU ADET	KOLİ ADET	Birim Fiyat TL / Ad.
	6031	A5 - 10XD	1NO	 0-1 Işıklı Mandal Buton 220V AC/DC	Yeşil	10	300	27.00
	6032	A5 - 01XD	1NC		Kırmızı	10	300	
	6033	A5 - 11XD	1NO		Sarı	10	300	
	6037	A5 - 10XD-110	1NO	 0-1 Işıklı Mandal Buton 110V AC/DC	Yeşil	10	300	27.00
	6038	A5 - 01XD-110	1NC		Kırmızı	10	300	
	6039	A5 - 11XD-110	1NO		Sarı	10	300	
	6043	A5 - 10XD-24	1NO	 0-1 Işıklı Mandal Buton 24V AC/DC	Yeşil	10	300	27.00
	6044	A5 - 01XD-24	1NC		Kırmızı	10	300	
	6045	A5 - 11XD-24	1NO		Sarı	10	300	
	6034	A5 - 20XSD	2NO	 1-0-2 Işıklı Mandal Buton 220V AC/DC	Yeşil	10	300	33.00
	6035	A5 - 02XSD	2NC		Kırmızı	10	300	
	6036	A5 - 21XSD	2NO		Sarı	10	300	
	6040	A5 - 20XSD-110	2NO	 1-0-2 Işıklı Mandal Buton 110V AC/DC	Yeşil	10	300	33.00
	6041	A5 - 02XSD-110	2NC		Kırmızı	10	300	
	6042	A5 - 21XSD-110	2NO		Sarı	10	300	
	6046	A5 - 20XSD-24	2NO	 1-0-2 Işıklı Mandal Buton 24V AC/DC	Yeşil	10	300	33.00
	6047	A5 - 02XSD-24	2NC		Kırmızı	10	300	
	6048	A5 - 21XSD-24	2NO		Sarı	10	300	

Q 22mm BUTON SERİSİ

40mm KALICI MANTAR BUTON

	SİPARİŞ KODU	ÜRÜN KODU	KONTAK	AÇIKLAMA	RENK	KUTU ADET	KOLİ ADET	Birim Fiyat TL / Ad.
	6054	A5 - 01ZS	1NC	Stop Mantar Buton	● Kırmızı	10	300	17.00

40mm KALICI ANAHTARLI MANTAR BUTON

	SİPARİŞ KODU	ÜRÜN KODU	KONTAK	AÇIKLAMA	RENK	KUTU ADET	KOLİ ADET	Birim Fiyat TL / Ad.
	6075	BZ - 01ZA	1NC	Anahtarlı Stop Mantar Buton	● Kırmızı	10	300	26.00

40mm KAYICI MANTAR BUTONLAR





	SİPARİŞ KODU	ÜRÜN KODU	KONTAK	AÇIKLAMA	RENK	KUTU ADET	KOLİ ADET	Birim Fiyat TL / Ad.
	6051	A5 - 01M	1NC	Stop Mantar Buton	● Kırmızı	10	300	15.00
	6052	A5 - 10M	1NO	Start Mantar Buton	● Yeşil	10	300	15.00
	6053	A5 - 41M	1NO	Start Mantar Buton	● Siyah	10	300	15.00





40mm KALICI MANTAR BUTONLAR





	SİPARİŞ KODU	ÜRÜN KODU	KONTAK	AÇIKLAMA	RENK	KUTU ADET	KOLİ ADET	Birim Fiyat TL / Ad.
	6055	A5 - 01ZF	1NC	Stop Mantar Buton	● STOP	10	300	30.00
	6058	A5 - 01ZFD	1NC	Led Işıklı Stop Mantar Buton 220V AC/DC	● STOP	10	300	40.00
	6057	A5 - 01ZFD-110	1NC	Led Işıklı Stop Mantar Buton 110V AC/DC	● STOP	10	300	40.00
	6056	A5 - 01ZFD-24	1NC	Led Işıklı Stop Mantar Buton 24V AC	● STOP	10	300	40.00





Q 22mm BUTON SERİSİ

İKİZ BUTONLAR

	SİPARİŞ KODU	ÜRÜN KODU	KONTAK	AÇIKLAMA	RENK	KUTU ADET	KOLİ ADET	Birim Fiyat TL / Ad.
	6063	A1 - 11R	1NO+1NC	İkiz Buton	 Yeşil - Kırmızı	10	300	21.00
	6066	A1 - 11RD	1NO+1NC	Işıklı İkiz Buton 220V AC/DC	 Yeşil - Kırmızı	10	300	32.00
	6067	A1 - 11RD-110	1NO+1NC	Işıklı İkiz Buton 110V AC/DC	 Yeşil - Kırmızı	10	300	32.00
	6068	A1 - 11RD-24	1NO+1NC	Işıklı İkiz Buton 24V AC/DC	 Yeşil - Kırmızı	10	300	32.00

	6059	A5 - 11R	1NO+1NC	İkiz Buton	 Yeşil - Kırmızı	10	300	24.00
	6062	A5 - 11RD	1NO+1NC	Işıklı İkiz Buton 220V AC/DC	 Kırmızı - Yeşil	10	300	36.00
	6061	A5 - 11RD-110	1NO+1NC	Işıklı İkiz Buton 110V AC/DC	 Kırmızı - Yeşil	10	300	36.00
	6060	A5 - 11RD-24	1NO+1NC	Işıklı İkiz Buton 24V AC/DC	 Kırmızı - Yeşil	10	300	36.00







	6064	A1 - 11R/5	1NO+1NC	1-0 İşaretli İkiz Buton	 Beyaz - Siyah	10	300	22.00
	6069	A1 - 11RD/5	1NO+1NC	1-0 Işıklı İkiz Buton 220V AC/DC	 Beyaz - Siyah	10	300	33.00
	6070	A1 - 11RD/5-110	1NO+1NC	1-0 Işıklı İkiz Buton 110V AC/DC	 Beyaz - Siyah	10	300	33.00
	6071	A1 - 11RD/5-24	1NO+1NC	1-0 Işıklı İkiz Buton 24V AC/DC	 Beyaz - Siyah	10	300	33.00

	6065	A1 - 11R/6	1NO+1NC	ON-OFF İkiz Buton	 Beyaz - Siyah	10	300	22.00
	6072	A1 - 11RD/6	1NO+1NC	Işıklı İkiz Buton 220V AC/DC	 Beyaz - Siyah	10	300	33.00
	6073	A1 - 11RD/6-110	1NO+1NC	Işıklı İkiz Buton 110V AC/DC	 Beyaz - Siyah	10	300	33.00
	6074	A1 - 11RD/6-24	1NO+1NC	Işıklı İkiz Buton 24V AC/DC	 Kırmızı - Yeşil	10	300	33.00

BUTON AKSESUARLARI

	SİPARİŞ KODU	ÜRÜN KODU	AÇIKLAMA	KUTU ADET	Birim Fiyat TL / Ad.
	6101	A - 10	1NO Start Kontakt	250	6.50
	6102	A - 01	1NO Stop Kontakt	250	6.50
	6103	A - D2	BA9S Led Kontakt Yuvası (Buton için)	200	6.50
	6104	FC	Plastik Buton Rozeti	100	1.20
	6105	FD/60	60mm Acil Stop Etiketi	100	3.60
	6106	EC5-1	Acil Stop Butonu Koruma Kapağı	20	13.00
	6107	FH	Buton Koruma Kapağı	3	12.00
	6108	BK	Buton Koruma Kılıfı	100	2.40





BOŞ BUTON KUTULARI

	SİPARİŞ KODU	ÜRÜN KODU	AÇIKLAMA	RENK	KUTU ADET	KOLİ ADET	Birim Fiyat TL / Ad.
	6114	GBK - 1	1'li Boş Kumanda Kutusu	Sarı-Siyah	1	100	8.30
	6116	GBK - 2	2'li Boş Kumanda Kutusu	Sarı-Siyah	1	100	11.00
	6118	GBK - 3	3'lü Boş Kumanda Kutusu	Sarı-Siyah	1	100	13.00
	6120	GBK - 4	4'ü Boş Kumanda Kutusu	Sarı-Siyah	1	50	17.00
	6122	GBK - 5	5'li Boş Kumanda Kutusu	Sarı-Siyah	1	50	26.00
	6124	GBK - 6	6'lı Boş Kumanda Kutusu	Sarı-Siyah	1	50	27.00





KUTULU ACİL STOP BUTON

	SİPARİŞ KODU	ÜRÜN KODU	KONTAK	AÇIKLAMA	RENK	KUTU ADET	KOLİ ADET	Birim Fiyat TL / Ad.
	6125	LAY2 - KSE542	NC	1'li Mantar Acil Stop Buton	Sarı-Siyah	1	100	23.00

Ø 22mm VOLTMETRE

	SİPARİŞ KODU	ÜRÜN KODU	ÇAP (mm)	AÇIKLAMA	RENK	KUTU ADET	KOLİ ADET	Birim Fiyat TL / Ad.
	6501	22 VS - K	22	24 - 550V Led'li Voltmetre	● Kırmızı	10	500	20.00
	6502	22 VS - Y	22	24 - 550V Led'li Voltmetre	● Yeşil	10	500	20.00
	6503	22 VS - S	22	24 - 550V Led'li Voltmetre	● Sarı	10	500	20.00
	6504	22 VS - M	22	24 - 550V Led'li Voltmetre	● Mavi	10	500	21.00
	6505	22 VS - B	22	24 - 550V Led'li Voltmetre	○ Beyaz	10	500	21.00

Ø 22mm AMPERMETRE

	SİPARİŞ KODU	ÜRÜN KODU	ÇAP (mm)	AÇIKLAMA	RENK	KUTU ADET	KOLİ ADET	Birim Fiyat TL / Ad.
	6511	22 - AS -K	22	0 - 100A Led'li Ampermetre Akım Trafolu	● Kırmızı	1	300	41.00
	6512	23 - AS -Y	22	0 - 100A Led'li Ampermetre Akım Trafolu	● Yeşil	1	300	41.00
	6513	24 - AS -S	22	0 - 100A Led'li Ampermetre Akım Trafolu	● Sarı	1	300	41.00
	6514	25 - AS - M	22	0 - 100A Led'li Ampermetre Akım Trafolu	● Mavi	1	300	43.00
	6515	26 - AS -B	22	0 - 100A Led'li Ampermetre Akım Trafolu	○ Beyaz	1	300	43.00

Ø 22mm LED'Lİ SİNYALLER



SİPARİŞ KODU	ÜRÜN KODU	ÇAP (mm)	AÇIKLAMA	RENK	KUTU ADET	KOLİ ADET	Birim Fiyat TL / Ad.
6601	22 - K	22	Led Sinyal 220V. AC-DC	● Kırmızı	10	500	4.60
6602	22 - Y	22	Led Sinyal 220V. AC-DC	● Yeşil	10	500	4.60
6603	22 - S	22	Led Sinyal 220V. AC-DC	● Sarı	10	500	4.60
6604	22 - M	22	Led Sinyal 220V. AC-DC	● Mavi	10	500	5.30
6605	22 - B	22	Led Sinyal 220V. AC-DC	○ Beyaz	10	500	5.30
6606	22 - 110V - K	22	Led Sinyal 110V. AC-DC	● Kırmızı	10	500	4.60
6607	22 - 110V - Y	22	Led Sinyal 110V. AC-DC	● Yeşil	10	500	4.60
6608	22 - 110V - S	22	Led Sinyal 110V. AC-DC	● Sarı	10	500	4.60
6609	22 - 110V - M	22	Led Sinyal 110V. AC-DC	● Mavi	10	500	5.30
6610	22 - 110V - B	22	Led Sinyal 110V. AC-DC	○ Beyaz	10	500	5.30
6611	22 - 24V - K	22	Led Sinyal 24V. AC-DC	● Kırmızı	10	500	4.60
6612	22 - 24V - Y	22	Led Sinyal 24V. AC-DC	● Yeşil	10	500	4.60
6613	22 - 24V - S	22	Led Sinyal 24V. AC-DC	● Sarı	10	500	4.60
6614	22 - 24V - M	22	Led Sinyal 24V. AC-DC	● Mavi	10	500	5.30
6615	22 - 24V - B	22	Led Sinyal 24V. AC-DC	○ Beyaz	10	500	5.30

Ø 16mm LED'Lİ SİNYALLER



SİPARİŞ KODU	ÜRÜN KODU	ÇAP (mm)	AÇIKLAMA	RENK	KUTU ADET	KOLİ ADET	Birim Fiyat TL / Ad.
6621	16 - K	16	Led Sinyal 220V. AC-DC	● Kırmızı	20	1.000	7.70
6622	16 - Y	16	Led Sinyal 220V. AC-DC	● Yeşil	20	1.000	7.70
6623	16 - S	16	Led Sinyal 220V. AC-DC	● Sarı	20	1.000	7.70
6624	16 - M	16	Led Sinyal 220V. AC-DC	● Mavi	20	1.000	9.00
6625	16 - B	16	Led Sinyal 220V. AC-DC	○ Beyaz	20	1.000	9.00
6626	16 - 110V - K	16	Led Sinyal 110V. AC-DC	● Kırmızı	20	1.000	7.70
6627	16 - 110V - Y	16	Led Sinyal 110V. AC-DC	● Yeşil	20	1.000	7.70
6628	16 - 110V - S	16	Led Sinyal 110V. AC-DC	● Sarı	20	1.000	7.70
6629	16 - 110V - M	16	Led Sinyal 110V. AC-DC	● Mavi	20	1.000	9.00
6630	16 - 110V - B	16	Led Sinyal 110V. AC-DC	○ Beyaz	20	1.000	9.00
6631	16 - 24V - K	16	Led Sinyal 24V. AC-DC	● Kırmızı	20	1.000	7.70
6632	16 - 24V - Y	16	Led Sinyal 24V. AC-DC	● Yeşil	20	1.000	7.70
6633	16 - 24V - S	16	Led Sinyal 24V. AC-DC	● Sarı	20	1.000	7.70
6634	16 - 24V - M	16	Led Sinyal 24V. AC-DC	● Mavi	20	1.000	9.00
6635	16 - 24V - B	16	Led Sinyal 24V. AC-DC	○ Beyaz	20	1.000	9.00

BA9S LED AMPULLER



SİPARİŞ KODU	ÜRÜN KODU	AÇIKLAMA	RENK	KUTU ADET	KOLİ ADET	Birim Fiyat TL / Ad.
6521	BA9SC - K	Led Ampul 220V. AC-DC	● Kırmızı	50	4.000	7.00
6522	BA9SC - Y	Led Ampul 220V. AC-DC	● Yeşil	50	4.000	7.00
6523	BA9SC - S	Led Ampul 220V. AC-DC	● Sarı	50	4.000	7.00
6524	BA9SC - M	Led Ampul 220V. AC-DC	● Mavi	50	4.000	9.50
6525	BA9SC - B	Led Ampul 220V. AC-DC	○ Beyaz	50	4.000	9.50
6526	BA9SC - 110V - K	Led Ampul 110V. AC-DC	● Kırmızı	50	4.000	7.00
6527	BA9SC - 110V - Y	Led Ampul 110V. AC-DC	● Yeşil	50	4.000	7.00
6528	BA9SC - 110V - S	Led Ampul 110V. AC-DC	● Sarı	50	4.000	7.00
6529	BA9SC - 110V - M	Led Ampul 110V. AC-DC	● Mavi	50	4.000	9.50
6530	BA9SC - 110V - B	Led Ampul 110V. AC-DC	○ Beyaz	50	4.000	9.50
6531	BA9SC - 24V - K	Led Ampul 24V. AC-DC	● Kırmızı	50	4.000	7.00
6532	BA9SC - 24V - Y	Led Ampul 24V. AC-DC	● Yeşil	50	4.000	7.00
6533	BA9SC - 24V - S	Led Ampul 24V. AC-DC	● Sarı	50	4.000	7.00
6534	BA9SC - 24V - M	Led Ampul 24V. AC-DC	● Mavi	50	4.000	9.50
6535	BA9SC - 24V - B	Led Ampul 24V. AC-DC	○ Beyaz	50	4.000	9.50

METAL LED'Lİ SİNYALLER



SİPARİŞ KODU	ÜRÜN KODU	ÇAP (mm)	AÇIKLAMA	RENK	KUTU ADET	KOLİ ADET	Birim Fiyat TL / Ad.
6551	C8 - K	8	Metal Led Sinyal 220V. AC-DC	● Kırmızı	50	600	11.00
6552	C8 - Y	8		● Yeşil	50	600	11.00
6553	C8 - S	8		● Sarı	50	600	11.00
6554	C8 - M	8		● Mavi	50	600	11.00
6555	C8 - B	8		○ Beyaz	50	600	11.00
6556	C8 - 24V - K	8	Metal Led Sinyal 24V. AC-DC	● Kırmızı	50	600	11.00
6557	C8 - 24V - Y	8		● Yeşil	50	600	11.00
6558	C8 - 24V - S	8		● Sarı	50	600	11.00
6559	C8 - 24V - M	8		● Mavi	50	600	11.00
6560	C8 - 24V - B	8		○ Beyaz	50	600	11.00
6561	C10 - K	10	Metal Led Sinyal 220V. AC-DC	● Kırmızı	30	360	13.00
6562	C10 - Y	10		● Yeşil	30	360	13.00
6563	C10 - S	10		● Sarı	30	360	13.00
6564	C10 - M	10		● Mavi	30	360	13.00
6565	C10 - B	10		○ Beyaz	30	360	13.00
6566	C10 - 24V - K	10	Metal Led Sinyal 24V. AC-DC	● Kırmızı	30	360	13.00
6567	C10 - 24V - Y	10		● Yeşil	30	360	13.00
6568	C10 - 24V - S	10		● Sarı	30	360	13.00
6569	C10 - 24V - M	10		● Mavi	30	360	13.00
6570	C10 - 24V - B	10		○ Beyaz	30	360	13.00
6571	C14 - K	14	Metal Led Sinyal 220V. AC-DC	● Kırmızı	15	180	24.00
6572	C14 - Y	14		● Yeşil	15	180	24.00
6573	C14 - S	14		● Sarı	15	180	24.00
6574	C14 - M	14		● Mavi	15	180	24.00
6575	C14 - B	14		○ Beyaz	15	180	24.00
6576	C14 - 24V - K	14	Metal Led Sinyal 24V. AC-DC	● Kırmızı	15	180	24.00
6577	C14 - 24V - Y	14		● Yeşil	15	180	24.00
6578	C14 - 24V - S	14		● Sarı	15	180	24.00
6579	C14 - 24V - M	14		● Mavi	15	180	24.00
6580	C14 - 24V - B	14		○ Beyaz	15	180	24.00

BUZZER'LAR

Ø 22mm LED'Lİ BUZZER (90dB)



SİPARİŞ KODU	ÜRÜN KODU	ÇAP (mm)	AÇIKLAMA	RENK	KUTU ADET	KOLİ ADET	Birim Fiyat TL / Ad.
6640	22DS/MS	22	Sesli Led Flaşör İkazlı 220V. AC/DC	● Kırmızı	10	500	22.00
6641	22DS/MS24	22	Sesli Led Flaşör İkazlı 24V. AC/DC	● Kırmızı	10	500	22.00

Ø 22mm SESLİ BUZZER (90dB)



SİPARİŞ KODU	ÜRÜN KODU	ÇAP (mm)	AÇIKLAMA	RENK	KUTU ADET	KOLİ ADET	Birim Fiyat TL / Ad.
6642	22DS/M	22	Sesli İkazlı 220V. AC/DC	● Siyah	10	500	21.00
6643	22DS/M24	22	Sesli İkazlı 24V. AC/DC	● Siyah	10	500	21.00

MOTORLU SİRENLER



SİPARİŞ KODU	ÜRÜN KODU	AÇIKLAMA	KUTU ADET	KOLİ ADET	Birim Fiyat TL / Ad.
6651	MS - 190 - 220	75mm Metal Gövde 220V. AC (110 - 130dB)	1	40	88.00
6652	MS - 190 - 24	75mm Metal Gövde 24V. AC (110 - 130dB)	1	40	88.00

ELEKTRONİK SİRENLER



SİPARİŞ KODU	ÜRÜN KODU	AÇIKLAMA	KUTU ADET	KOLİ ADET	Birim Fiyat TL / Ad.
6656	ES - 50 - 12/24	Plastik Gövde 120dB 12-24V. AC/DC	1	100	44.00
6658	ES - 60 - 220	Plastik Gövde 120dB 220V. AC	1	100	75.00
6657	ES - 60 - 12/24	Plastik Gövde 120dB 12-24V. AC	1	100	58.00

Ø 22mm POTANSİYOMETRE



SİPARİŞ KODU	ÜRÜN KODU	ÇAP (mm)	AÇIKLAMA	KUTU ADET	KOLİ ADET	Birim Fiyat TL / Ad.
6665	APT22 - 5K	22	5K Potansiyometre Tek Turlu 220V. AC	10	500	52.00
6666	APT22 - 10K	22	10K Potansiyometre Tek Turlu 220V. AC	10	500	52.00

PANO İÇİ TERMOSTATLAR

Çalışma Ömrü : 100.000 Açma Kapama
 Ölçüler : 60x33x43
 Ağırlık : 40 gr
 Koruma Sınıfı : IP20



SİPARİŞ KODU	ÜRÜN KODU	KONTAK	AÇIKLAMA ve ÇALIŞMA SICAKLIĞI	KUTU ADET	KOLİ ADET	Birim Fiyat TL / Ad.
6682	KTO - 011	NC	Isıtma Termostatı (0 - 60°C)	1	300	38.00
6681	KTS - 011	NO	Soğutma Termostatı (0 - 60°C)	1	300	38.00





AKS SERİSİ KAPI SIVIÇLERİ







SİPARİŞ KODU	ÜRÜN KODU	KONTAK	AÇIKLAMA	KUTU ADET	KOLİ ADET	Birim Fiyat TL / Ad.
6825	AKS - 10	NO	Açık Kontak Kapaı Sivici	50	500	10.00
6826	AKS - 01	NC	Kapalı Kontak Kapaı Sivici	50	500	10.00

VİNÇ KUMANDA BUTONLARI

PLASTİK VİNÇ KUMANDALAR (IP67)

	SİPARİŞ KODU	ÜRÜN KODU	AÇIKLAMA	KUTU ADET	KOLİ ADET	Birim Fiyat USD / Ad.
	6701	VK - 2	Plastik Vinç Kumanda 2'li Tek Hızlı	1	72	4.40
	6702	VK - 4	Plastik Vinç Kumanda 4'li Tek Hızlı	1	48	5.70
	6703	VK - 6	Plastik Vinç Kumanda 6'li Tek Hızlı	1	42	7.50
	6704	VK - 8	Plastik Vinç Kumanda 8'li Tek Hızlı	1	36	10.00

ACİL STOPLU PLASTİK VİNÇ KUMANDALAR (IP67)

	6705	VKB - 3	Plastik Vinç Kumanda 3'li Tek Hızlı	1	50	17.50
	6706	VKB - 5	Plastik Vinç Kumanda 5'li Tek Hızlı	1	40	24.00
	6707	VKB - 7	Plastik Vinç Kumanda 7'li Tek Hızlı	1	30	31.00
	6708	VKB - 9	Plastik Vinç Kumanda 9'li Tek Hızlı	1	20	38.00



GÜVEN
ELEKTRİK ELEKTRONİK LTD. ŞTİ.

SWITCH GRUBU



www.guvenelektrik.com.tr



GLS SERİSİ LİMİT SWITCH

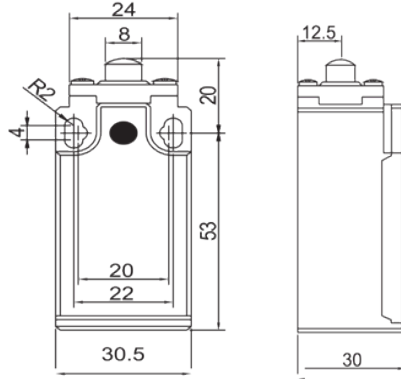

Birim Fiyat USD / Ad.	5.00
SİPARİŞ KODU	6801
ÜRÜN KODU	GLS -101
KUTU ADET	10
KOLİ ADETİ	100
AÇIKLAMA	Kısa Dikey Metal Pim 1NO + 1NC

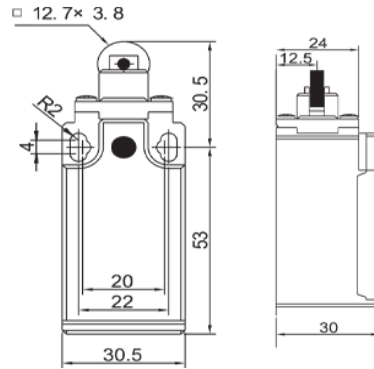

Birim Fiyat USD / Ad.	5.00
SİPARİŞ KODU	6802
ÜRÜN KODU	GLS -103
KUTU ADET	10
KOLİ ADETİ	100
AÇIKLAMA	Dikey Metal Makaralı 1NO + 1NC

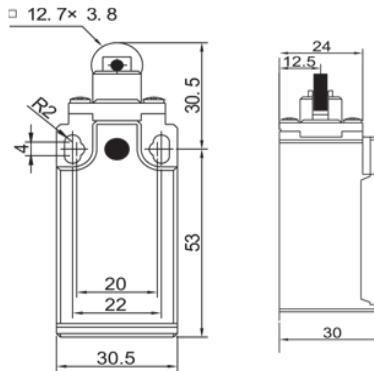

Birim Fiyat USD / Ad.	5.20
SİPARİŞ KODU	6803
ÜRÜN KODU	GLS -103R
KUTU ADET	10
KOLİ ADETİ	100
AÇIKLAMA	Dikey Metal Makaralı Resetli 1NO + 1NC

RESETLİ

GLS SERİSİ LİMİT SWITCH

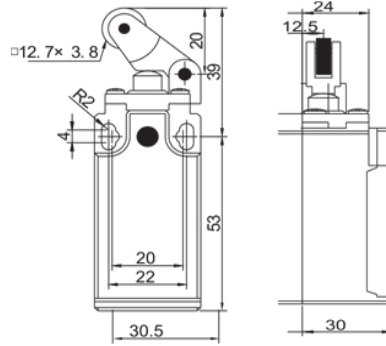

Birim Fiyat USD / Ad.	5.00
SİPARİŞ KODU	6804
ÜRÜN KODU	GLS -111
KUTU ADET	10
KOLİ ADETİ	100
AÇIKLAMA	Açısal Metal Makaralı Tek Yön 1NO + 1NC

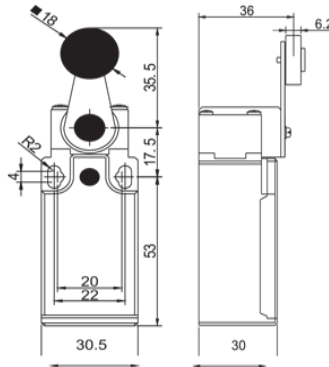

Birim Fiyat USD / Ad.	5.00
SİPARİŞ KODU	6805
ÜRÜN KODU	GLS -121
KUTU ADET	10
KOLİ ADETİ	100
AÇIKLAMA	Dikey Metal Makaralı Çift Yön 1NO + 1NC

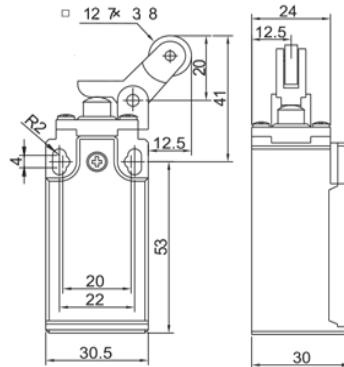

Birim Fiyat USD / Ad.	5.00
SİPARİŞ KODU	6806
ÜRÜN KODU	GLS -127
KUTU ADET	10
KOLİ ADETİ	100
AÇIKLAMA	Ters Açısal Metal Makaralı Tek Yön 1NO + 1NC

GLS SERİSİ LİMİT SWITCH

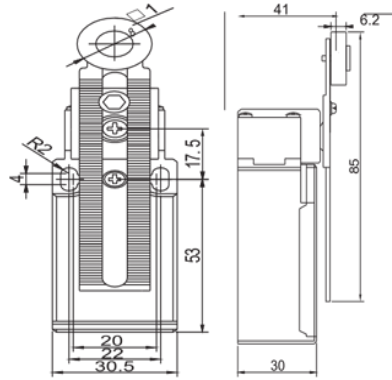

Birim Fiyat USD / Ad.	5.20
SİPARİŞ KODU	6807
ÜRÜN KODU	GLS -131
KUTU ADET	10
KOLİ ADETİ	100
AÇIKLAMA	Ayarlanabilir Metal Makaralı Çift Yön 1NO + 1NC

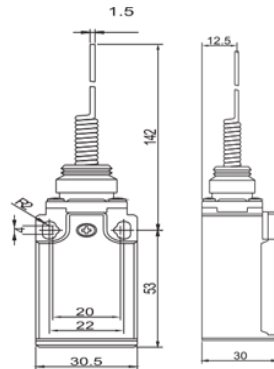

Birim Fiyat USD / Ad.	5.20
SİPARİŞ KODU	6808
ÜRÜN KODU	GLS -161
KUTU ADET	10
KOLİ ADETİ	100
AÇIKLAMA	Çok Yönlü Spiral Tel Uç 1NO + 1NC

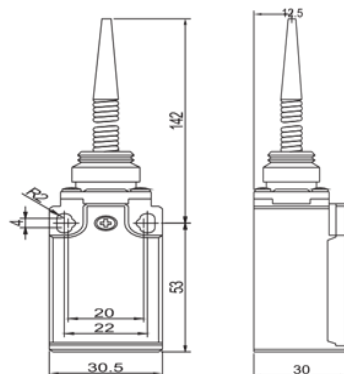

Birim Fiyat USD / Ad.	5.20
SİPARİŞ KODU	6809
ÜRÜN KODU	GLS -171
KUTU ADET	10
KOLİ ADETİ	100
AÇIKLAMA	Çok Yönlü Spiral Plastik Uç 1NO + 1NC

GLS SERİSİ LİMİT SWITCH

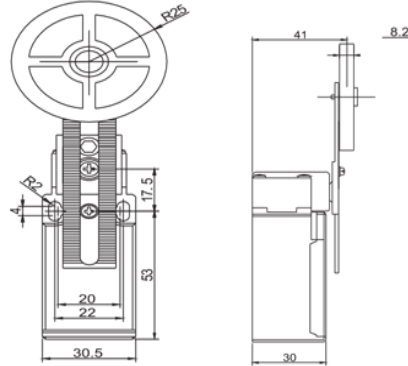

Birim Fiyat USD / Ad.	5.20
SİPARİŞ KODU	6810
ÜRÜN KODU	GLS -191
KUTU ADET	1
KOLİ ADETİ	50
AÇIKLAMA	Ayarlanabilir Kauçuk Makara Çift Yön 1NO + 1NC

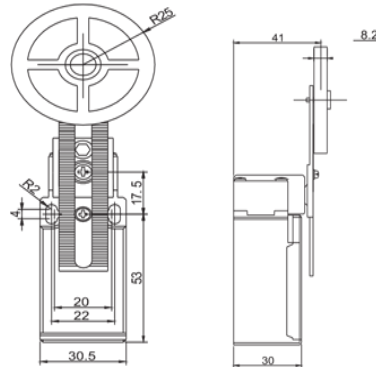

RESETLİ

Birim Fiyat USD / Ad.	6.50
SİPARİŞ KODU	6800
ÜRÜN KODU	GLS -191R
KUTU ADET	1
KOLİ ADETİ	50
AÇIKLAMA	Ayarlanabilir Kauçuk Makara Çift Yön Resetli 1NO + 1NC



AZ SERİSİ MİKRO SWITCH

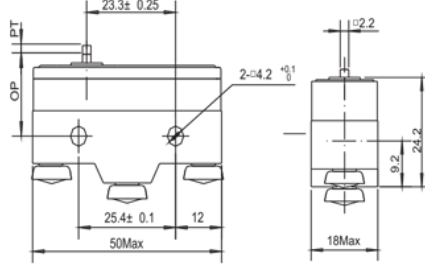

Birim Fiyat USD / Ad.	2.70
SİPARİŞ KODU	6811
ÜRÜN KODU	AZ - 15G - B
KUTU ADET	20
KOLİ ADETİ	360
AÇIKLAMA	İnce Kısa Pimli 15A 1NO + 1NC

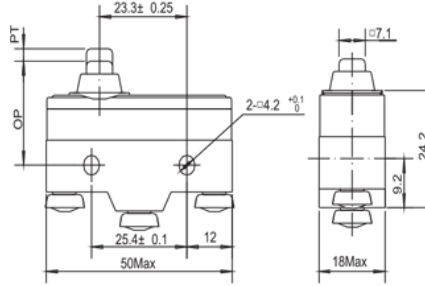

Birim Fiyat USD / Ad.	2.70
SİPARİŞ KODU	6812
ÜRÜN KODU	AZ - 15GD - B
KUTU ADET	20
KOLİ ADETİ	360
AÇIKLAMA	Kalın Uzun Pimli 15A 1NO + 1NC

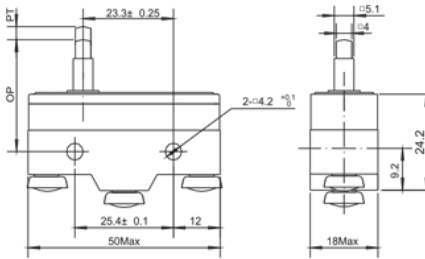

Birim Fiyat USD / Ad.	3.10
SİPARİŞ KODU	6813
ÜRÜN KODU	AZ - 15GS - B
KUTU ADET	20
KOLİ ADETİ	360
AÇIKLAMA	İnce Uzun Pimli 15A 1NO + 1NC

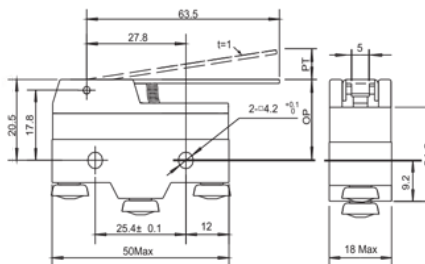

Birim Fiyat USD / Ad.	2.70
SİPARİŞ KODU	6814
ÜRÜN KODU	AZ - 15GW - B
KUTU ADET	20
KOLİ ADETİ	360
AÇIKLAMA	Uzun Palet 15A 1NO + 1NC

AZ SERİSİ MİKRO SWİTÇ

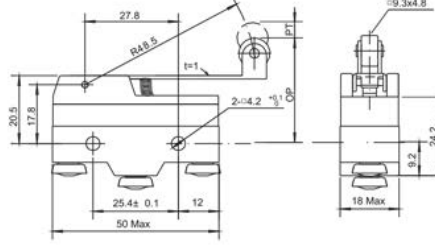

Birim Fiyat USD / Ad.	3.10
SİPARİŞ KODU	6815
ÜRÜN KODU	AZ - 15GW2 - B
KUTU ADET	20
KOLİ ADETİ	360
AÇIKLAMA	Uzun Paletli Metal Makaralı 15A 1NO + 1NC

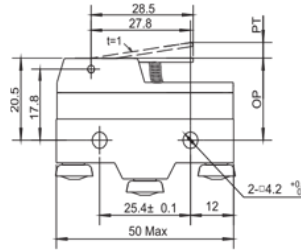

Birim Fiyat USD / Ad.	2.70
SİPARİŞ KODU	6817
ÜRÜN KODU	AZ - 15GW21 - B
KUTU ADET	20
KOLİ ADETİ	360
AÇIKLAMA	Kısa Paletli 15A 1NO + 1NC

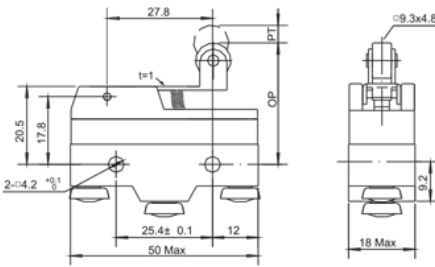

Birim Fiyat USD / Ad.	3.10
SİPARİŞ KODU	6818
ÜRÜN KODU	AZ - 15GW22 - B
KUTU ADET	20
KOLİ ADETİ	360
AÇIKLAMA	Kısa Metal Makaralı 15A 1NO + 1NC

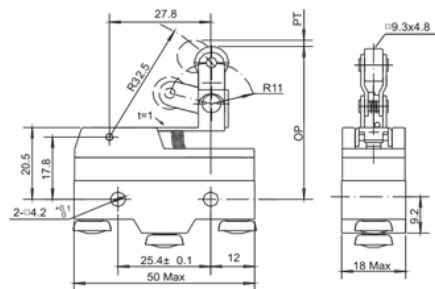

Birim Fiyat USD / Ad.	3.20
SİPARİŞ KODU	6819
ÜRÜN KODU	AZ - 15GW2277 - B
KUTU ADET	20
KOLİ ADETİ	360
AÇIKLAMA	Tahrikli Metal Makaralı 15A 1NO + 1NC

AZ SERİSİ MİKRO SWITCH

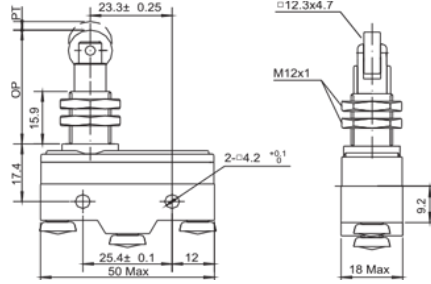

Birim Fiyat USD / Ad.	4.00
SİPARİŞ KODU	6820
ÜRÜN KODU	AZ - 15GQ22 - B
KUTU ADET	20
KOLİ ADETİ	360
AÇIKLAMA	Dikey Metal Makaralı 15A 1NO + 1NC

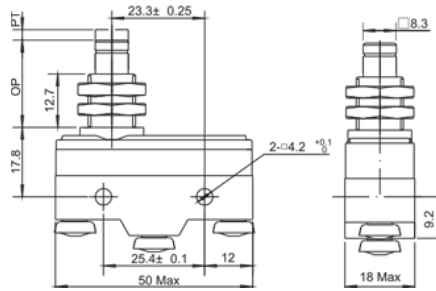

Birim Fiyat USD / Ad.	3.80
SİPARİŞ KODU	6821
ÜRÜN KODU	AZ - 15GQ - B
KUTU ADET	20
KOLİ ADETİ	360
AÇIKLAMA	Kalın Kısa Metal Pimli 15A 1NO + 1NC

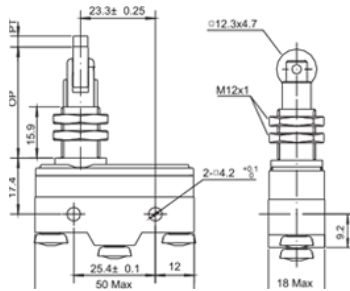

Birim Fiyat USD / Ad.	4.00
SİPARİŞ KODU	6822
ÜRÜN KODU	AZ - 15GQ21 - B
KUTU ADET	20
KOLİ ADETİ	360
AÇIKLAMA	Yan Dik Metal Makaralı 15A 1NO + 1NC

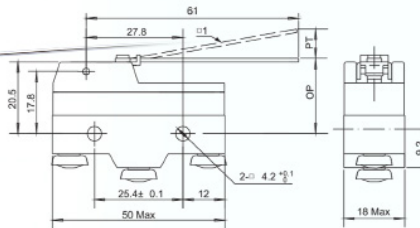

Birim Fiyat USD / Ad.	3.00
SİPARİŞ KODU	6823
ÜRÜN KODU	AZ - 15HW24 - B
KUTU ADET	20
KOLİ ADETİ	360
AÇIKLAMA	Uzun Tel Palet 15A 1NO + 1NC

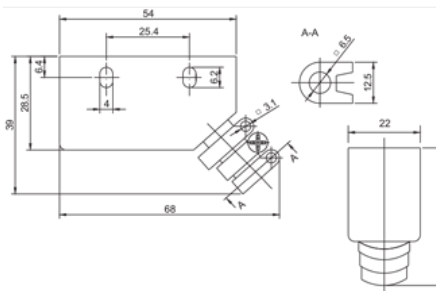

Birim Fiyat USD / Ad.	0.60
SİPARİŞ KODU	6824
ÜRÜN KODU	XAP - Y
KUTU ADET	20
KOLİ ADETİ	360
AÇIKLAMA	Koruma Kabi

GMS SERİSİ MİKRO SWITCH



Birim Fiyat USD / Ad.	1.00		
SİPARİŞ KODU	6830	ÜRÜN KODU	GMS - 100C
KUTU ADET	100	KOLİ ADET	1.800
AÇIKLAMA	10 Amper Plastik Pimli Mikro Switch		

Birim Fiyat USD / Ad.	1.00		
SİPARİŞ KODU	6831	ÜRÜN KODU	GMS - 101C
KUTU ADET	100	KOLİ ADET	1.800
AÇIKLAMA	10 Amper Orta Kollu Mikro Switch		

Birim Fiyat USD / Ad.	1.00		
SİPARİŞ KODU	6832	ÜRÜN KODU	GMS - 102C
KUTU ADET	100	KOLİ ADET	1.800
AÇIKLAMA	10 Amper Kısa Kollu Mikro Switch		

Birim Fiyat USD / Ad.	1.00		
SİPARİŞ KODU	6833	ÜRÜN KODU	GMS - 103C
KUTU ADET	100	KOLİ ADET	1.800
AÇIKLAMA	10 Amper Uzun Kollu Metal Makaralı Mikro Switch		

Birim Fiyat USD / Ad.	1.00		
SİPARİŞ KODU	6834	ÜRÜN KODU	GMS - 104C
KUTU ADET	100	KOLİ ADET	1.800
AÇIKLAMA	10 Amper Kısa Kollu Metal Makaralı Mikro Switch		

Birim Fiyat USD / Ad.	1.00		
SİPARİŞ KODU	6835	ÜRÜN KODU	GMS - 105C
KUTU ADET	100	KOLİ ADET	1.800
AÇIKLAMA	10 Amper Uzun Kollu Mikro Switch		

Birim Fiyat USD / Ad.	1.00		
SİPARİŞ KODU	6836	ÜRÜN KODU	GMS - 106C
KUTU ADET	100	KOLİ ADET	1.800
AÇIKLAMA	10 Amper Kıvrık Kollu Mikro Switch		



GÜVEN
ELEKTRİK ELEKTRONİK LTD. ŞTİ.

AYAK PEDALLARI



www.guvenelektrik.com.tr



AYAK PEDALLARI

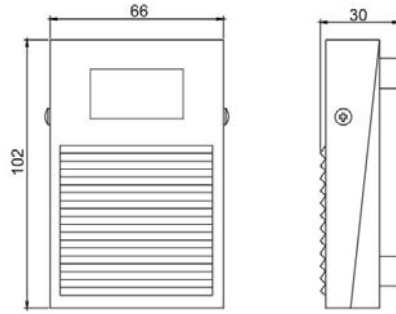

Birim Fiyat USD / Ad.	5.00	5.30
SİPARİŞ KODU	6900	6901
ÜRÜN KODU	AP - 1	
KUTU ADET	1	
KOLİ ADETİ	60	
AÇIKLAMA	Metal Döküm Pedal 1 mt Kablolu 2 mt Kablolu	

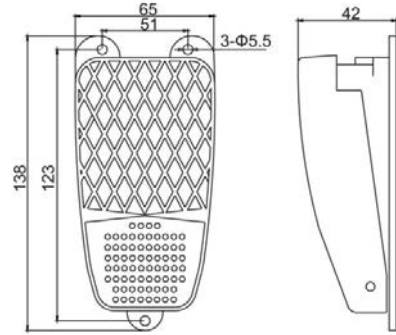

Birim Fiyat USD / Ad.	7.20
SİPARİŞ KODU	6902
ÜRÜN KODU	AP - 2
KUTU ADET	1
KOLİ ADETİ	60
AÇIKLAMA	Alüminyum Döküm Pedal 1mt Kablolu

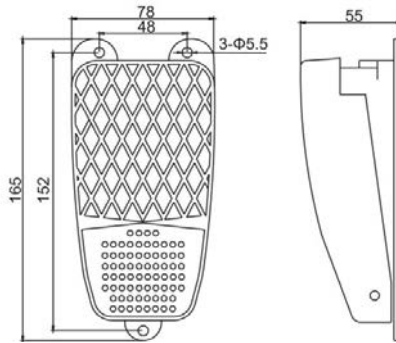

Birim Fiyat USD / Ad.	9.20
SİPARİŞ KODU	6903
ÜRÜN KODU	AP - 3
KUTU ADET	1
KOLİ ADETİ	40
AÇIKLAMA	Alimünyum Döküm Pedal 1mt Kablolu

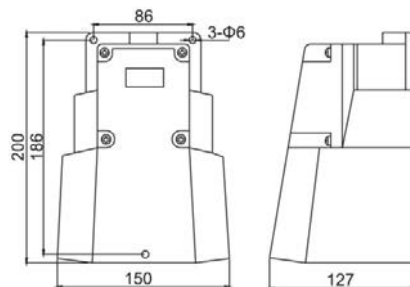

Birim Fiyat USD / Ad.	23.00
SİPARİŞ KODU	6904
ÜRÜN KODU	AP - 9
KUTU ADET	1
KOLİ ADETİ	12
AÇIKLAMA	Metal Döküm Pedal



GÜVEN

ELEKTRİK ELEKTRONİK LTD. ŞTİ.

Başarılar Karşılıklı Güven'e Bağlıdır.



MERKEZ

İkitelli Organize Sanayi Bölgesi
Mutsan Sanayi Sitesi M12 Blok No. 52-54 Başakşehir/İstanbul
Tel. : (0212) 485 05 40 Faks : (0212) 486 05 61



ŞUBE

Okçu Musa Cad. Menevşe İşhanı No. 22/199-200 Karaköy/İstanbul
Tel. : (0212) 361 69 61 Faks : (0212) 361 69 63